



Brown Bag It

Objective

The student will match initial phonemes to graphemes.

Materials

- ▶ Small brown paper bags
Label each of 26 bags with one letter of the alphabet.
- ▶ Print resources (e.g., magazines and catalogs)
Review the print resources to ensure the information is appropriate for young children.
- ▶ Scissors

Activity

Students sort pictures by initial sounds into bags labeled with the letters of the alphabet.

1. Place paper bags in alphabetical order on a flat surface. Place print resources and scissors at the center.
2. The student cuts 10-20 pictures from the print resources.
3. Names each picture, says its initial sound (e.g., “basketball, /b/”), and places picture in corresponding bag.
4. Continues until all pictures are sorted.
5. Teacher evaluation

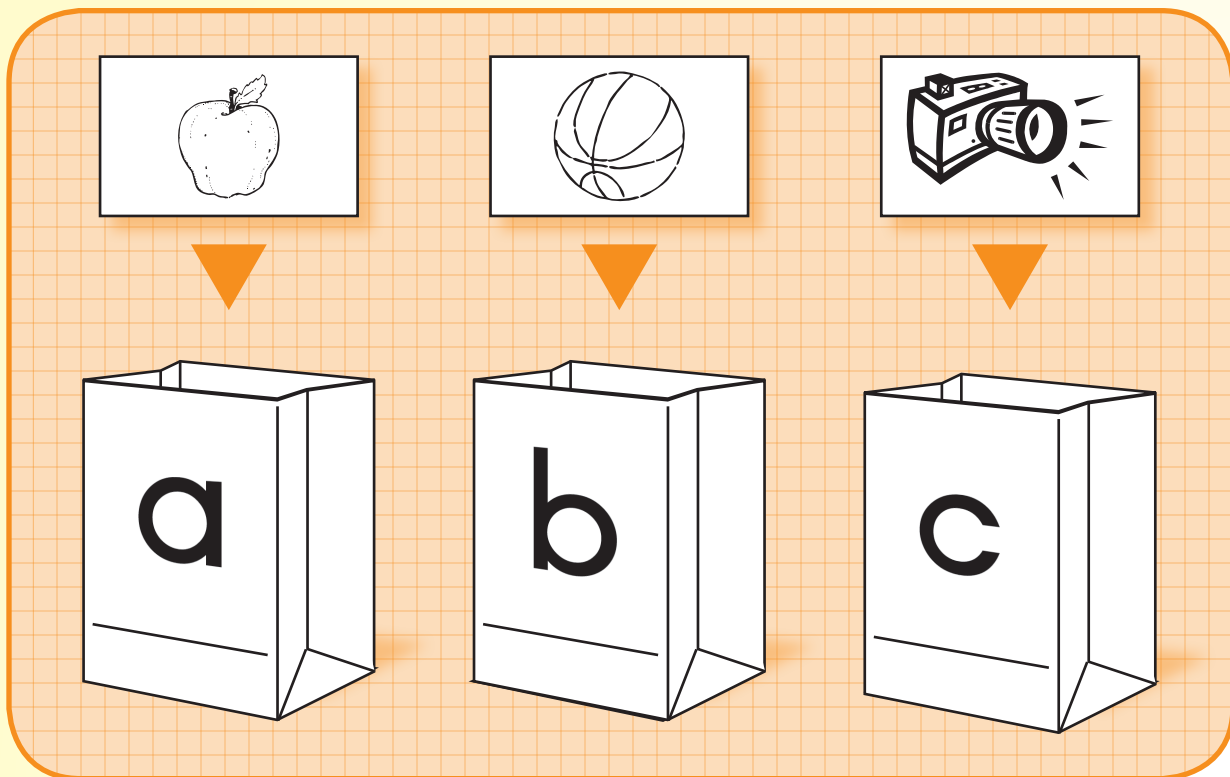

Extensions and Adaptations

- ▶ Check the pictures in the bags for initial sound matches during a whole group activity.
- ▶ Use pictures to make a class alphabet book.
- ▶ Sort pictures by final or medial sounds.



Objective

The student will match initial phonemes to graphemes.

Materials

- ▶ Student photographs
- ▶ Poster board

Write the letters of the alphabet vertically down the left side of the poster board.

Activity

Students match the initial sounds in classmates' names to letters using student photographs.

1. Place scattered student photographs on a flat surface. Place poster board at the center.
2. Working in pairs, students select a photograph, name the student, and say the initial sound in the student's name.
3. Place photograph on the chart beside the letter that corresponds to the initial sound.
4. Continue until all photographs are sorted.
5. Peer evaluation

A poster board activity showing a grid of letters (A, B, C, D, E, F) on the left and several student photographs on the right. The letters are arranged vertically. The photographs are arranged in a grid: one at the top, two in the middle, and one at the bottom. The letters are A, B, C, D, E, F. The photographs are of a boy, a girl, and a boy.

Extensions and Adaptations

- ▶ Sort student names by final sound.
- ▶ Sort picture cards by initial sound (Activity Master P.013.AM1a - P.013.AM1c).

Phonics

Photo Chart

P.013.AM1a

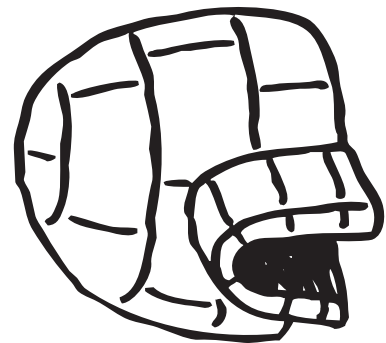
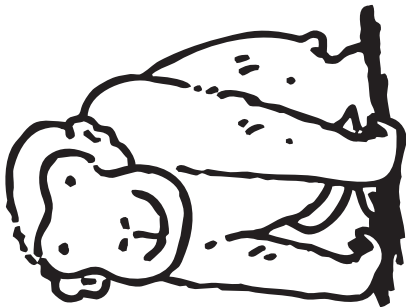
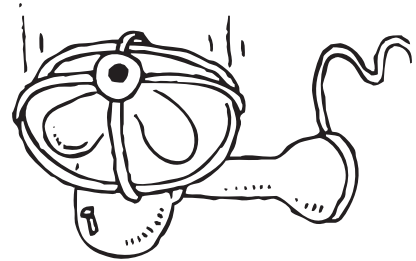
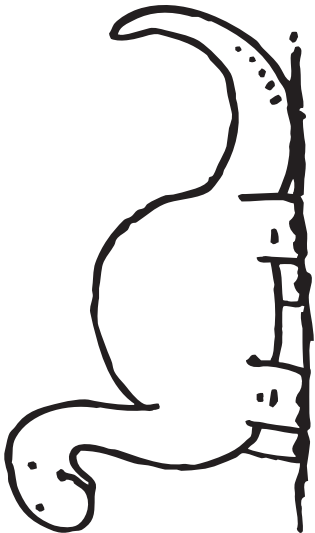
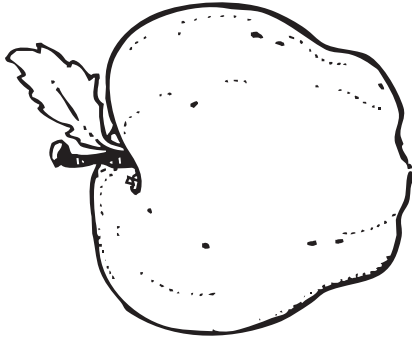

picture cards: apple, ball, camera, dinosaur, egg, fan, gorilla, hug, igloo



P.013.AM1b

Photo Chart

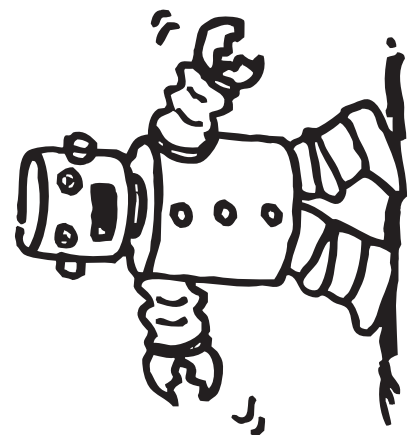
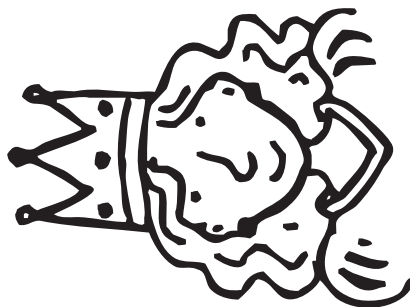
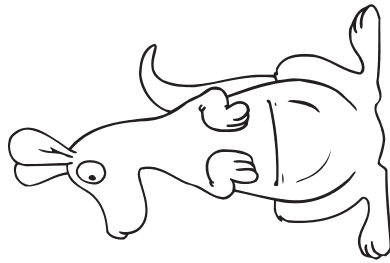
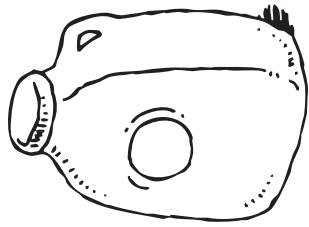

picture cards: jug, kangaroo, lion, monkey, nose, ostrich, popcorn, queen, robot



Phonics

Photo Chart

P.013.AM1c

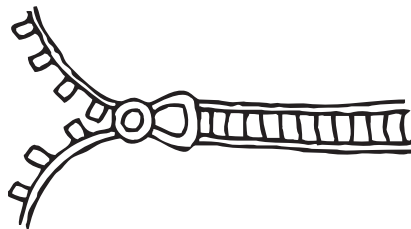
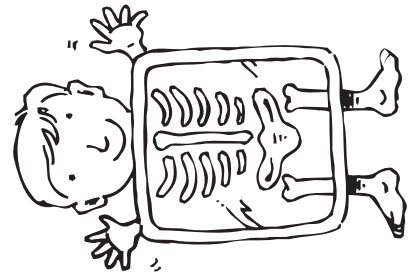
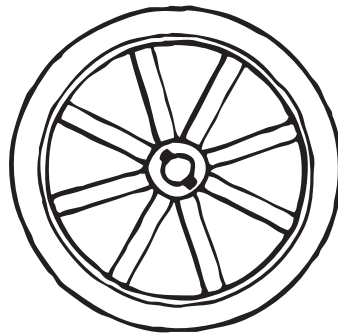
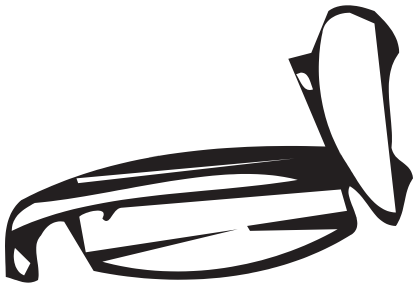
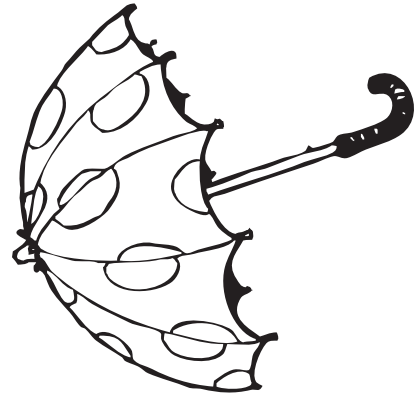
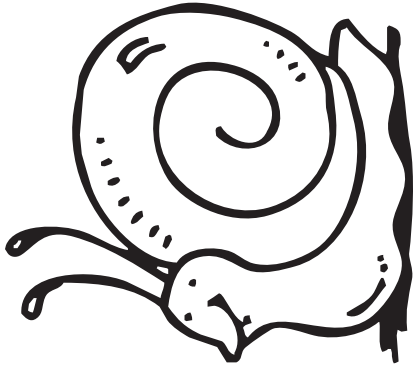

picture cards: snail, tiger, umbrella, vacuum, wheel, x-ray, yak, zipper





Objective

The student will match initial phonemes to graphemes.

Materials

- ▶ 12" x 18" construction paper
Laminate the finished product for placemats.
- ▶ Letter stamps and stamp pads
- ▶ Print resources (e.g., magazines and catalogs)
Review the print resources to ensure the information is appropriate for young children.
- ▶ Scissors
- ▶ Glue

Activity

Students select pictures with the same initial sound as their first name and make placemats.

1. Place print resources, letter stamps, stamp pad, scissors, and glue on a flat surface. Provide each student with a piece of construction paper.
2. The student stamps each letter of his name on the construction paper and says the initial sound.
3. Selects and cuts pictures with the same initial sound as in the student's name.
4. Glues pictures on the construction paper.
5. Continues until there are five to ten pictures on placemat.
6. Teacher evaluation



Extensions and Adaptations

- ▶ Select pictures corresponding to the final sound in name.
- ▶ Use last names.



Words Around Us Memory Game

Objective

The student will match initial phonemes to graphemes.

Materials

- ▶ Initial sound picture cards (Activity Master P.LSC-I.1 - P.LSC-I.22)
Choose eight-to-ten target initial sound picture cards.
- ▶ Uppercase or lowercase letter cards (Activity Master P.007.AM2a - P.007.AM2i)
Choose letter cards that correspond to the initial sound for each target picture card.

Activity

Students pair initial sound picture cards with the corresponding letter while playing a memory game.

1. Place picture cards and letters cards face down in separate rows.
2. Taking turns, students select two cards, name the letter (e.g., “v”) or name the picture, and say its initial sound (e.g., “vacuum, /v/”).
3. Determine if there is a letter-sound match. If there is a match (e.g., “v, /v/”) pick up the cards, place to the side and take another turn. If cards do not match (e.g., “v, /b/”), or if two letter cards or two picture cards are selected, return to their original places, and allow partner to take a turn.
4. Continue until all letter-sound pairs are made.
5. Peer evaluation

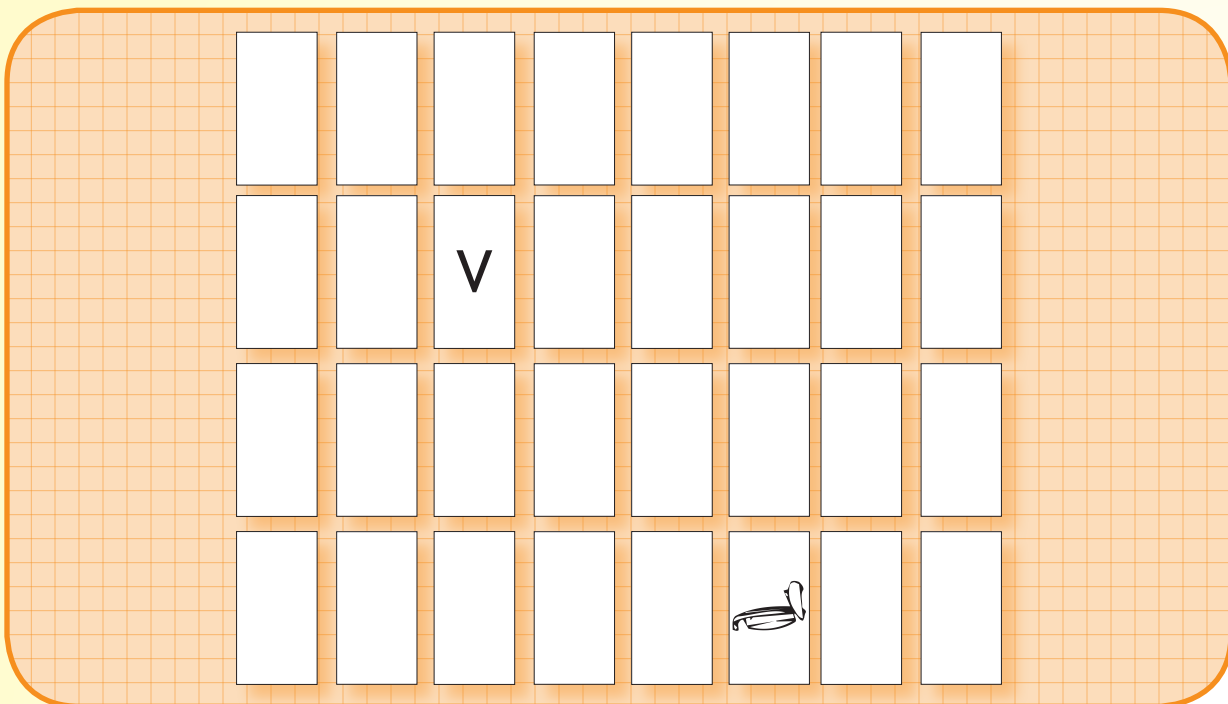

Extensions and Adaptations

- ▶ Put the pictures and cards in alphabetical order.
- ▶ Match cards by final sound.
- ▶ Match cards by number of syllables.
- ▶ Match cards by number of phonemes.



Objective

The student will match initial phonemes to graphemes.

Materials

- ▶ Picture/letter domino cards (Activity Master P.016.AM1a - P.016.AM1e)
Copy on card stock, laminate, and cut.

Activity

Students match initial sounds of pictures to letters while playing a domino game.

1. Scatter domino picture cards face up on a flat surface.
2. Taking turns, student one places the START domino on the table, names the picture on the other side of the domino, and says its initial sound (i.e., “lamp, /l/”).
3. Looks for a domino with the letter that corresponds to the initial sound, names it, and says its sound (i.e., “l, /l/”). Connects the two dominoes.
4. Student two names the picture on the other side of the domino (i.e., “hammer”), says its initial sound (i.e., “/h/”), and finds the domino with the corresponding letter. Names the letter and says its sound (i.e., “h, /h/”). Connects it to the domino.
5. Continue until all dominoes are connected.
6. Peer evaluation

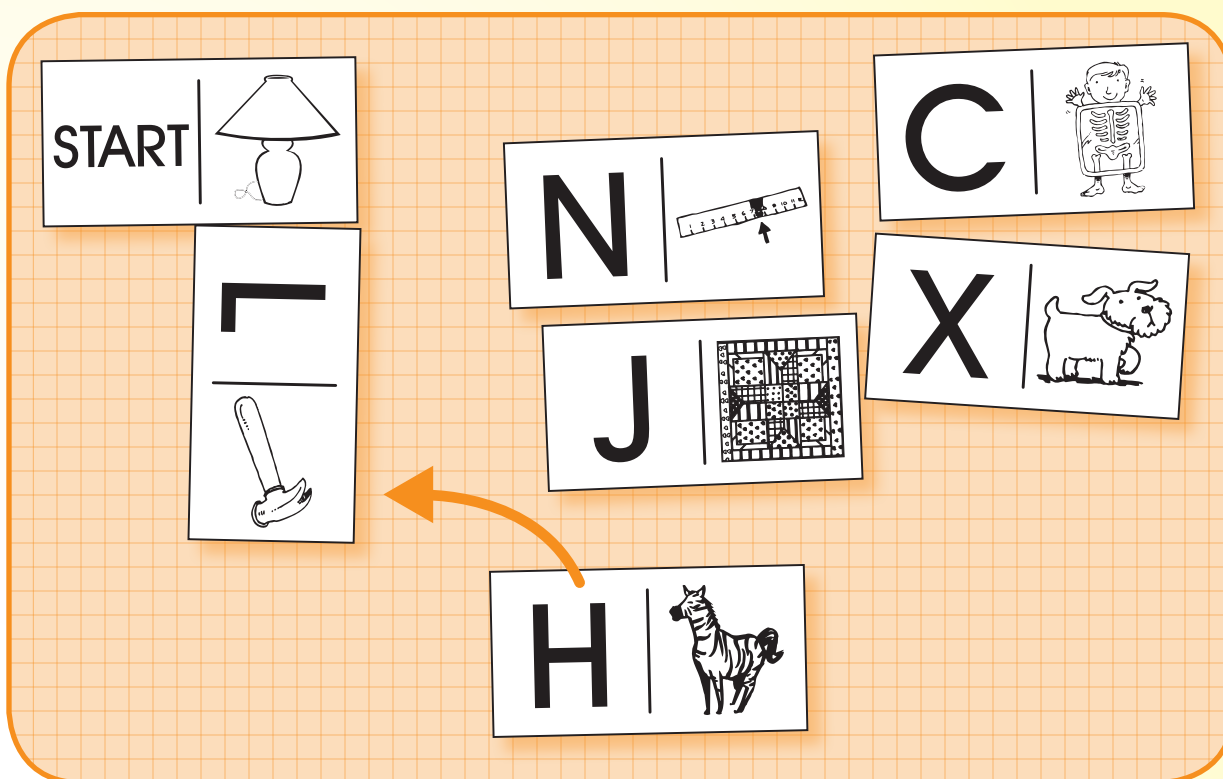

Extensions and Adaptations

- ▶ Make and use final sound picture/letter domino cards (Activity Master P.016.AM2).
- ▶ Make and use medial sound picture/letter domino cards (Activity Master P.016.AM2).
- ▶ Make and use upper- and lowercase letter domino cards (Activity Master P.016.AM2).

Phonics

Letter-Sound Dominoes

P.016.AM1a

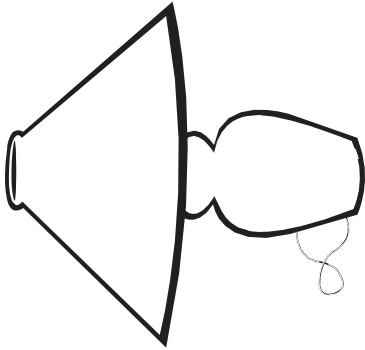

START

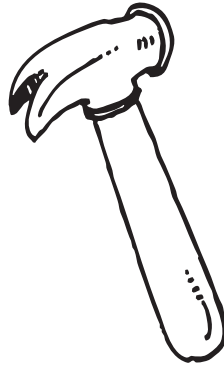

L



H

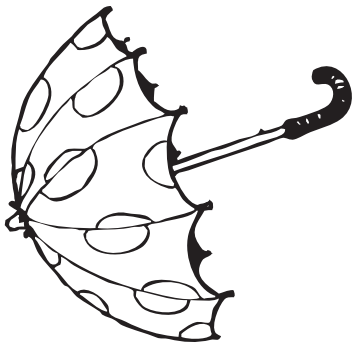

Z

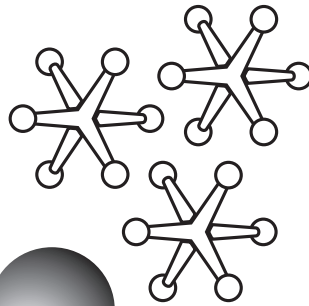

U

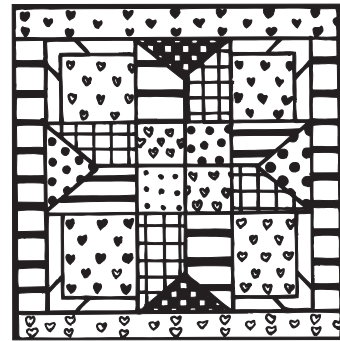

J

domino cards: START/lamp, L/hammer, H/zebra, Z/umbrella, U/jacks, J/quilt



P.016.AM1b

Letter-Sound Dominoes

9



Q

N

I

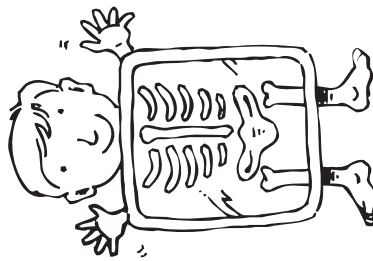
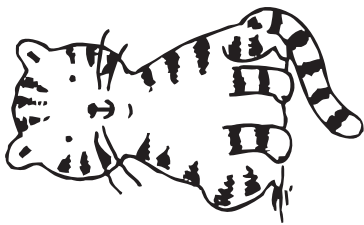

M

C

X

domino cards: Q/nine, N/inch, I/monkey, M/cat, C/x-ray, X/dog



Phonics

Letter-Sound Dominoes

P.016.AM1c



D



W

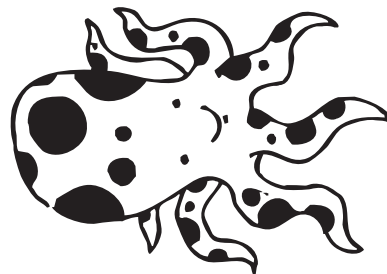

P



O



T

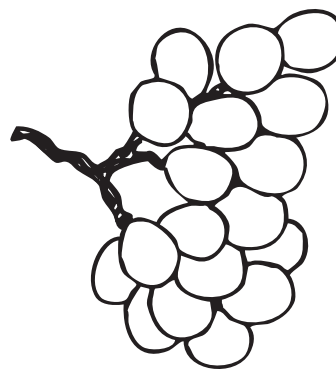

K

domino cards: D/wink, W/pencil, P/octopus, O/tent, T/kiss, K/grapes



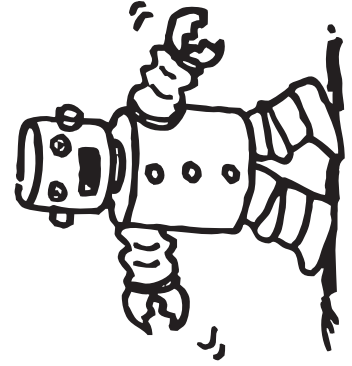

G

Y

E

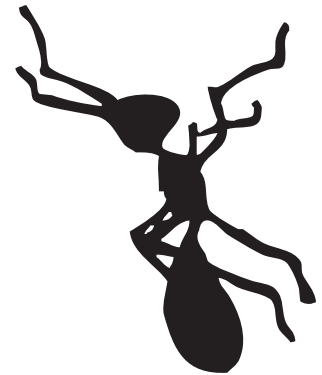
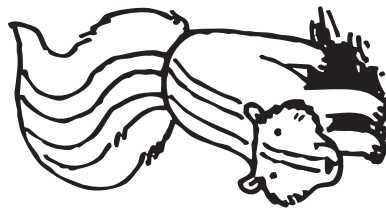
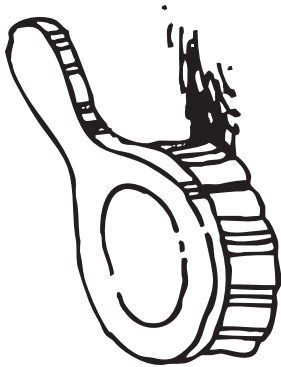

R

B

S

domino cards: G/yak, Y/egg, E/robot, R/brush, B/skunk, S/ant



Phonics

Letter-Sound Dominoes

P.016.AMIe

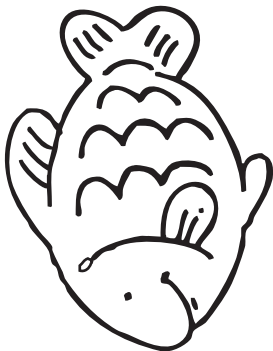
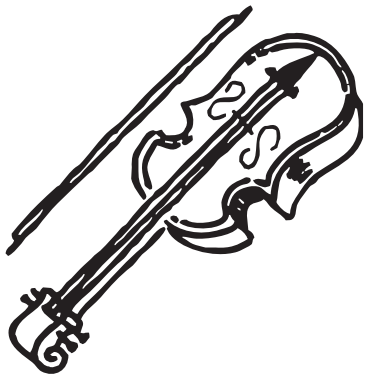

END

A

V

F

domino cards: A/violin, V/fish, F/END



P.016.AM2

Letter-Sound Dominoes

<hr/>	<hr/>	<hr/>
<hr/>	<hr/>	<hr/>

blank domino cards





Letter Bag



Objective

The student will match final phonemes to graphemes.



Materials

- ▶ Target final sound objects
- ▶ Non-target final sound objects
- ▶ Bag
Place all objects in the bag.
- ▶ Student sheet (Activity Master P.017.SS)
Write the target sound letter in the upper left hand corner.
- ▶ Pencil



Activity

Students sort, illustrate, and write the final sounds of objects.

1. Place the bag of objects on a flat surface. Provide the student with a student sheet.
2. The student selects one object from the bag, names it, and says its final sound (e.g., “mug, /g/”).
3. Names the target letter, says its sound (e.g., “g, /g/”), and determines if the final sound of the object corresponds.
4. If it matches, illustrates object in target letter column. If it does not match, illustrates object in  column. Writes letter for final sound beside it.
5. Continues until all objects are sorted and illustrated.
6. Teacher evaluation

The student sheet is titled "Letter Bag" and includes a "Name" field, the code "P.017.SS", and the title "Letter Bag". It features a two-column table. The left column has a large lowercase letter 'g' at the top. The right column has a "no" symbol (a circle with a diagonal slash) at the top. Below the 'g' column, there are three rows, each containing a drawing of an object and the letter 'g' to its right: a cow, a mug, and a shopping bag. Below the 'no' column, there is one row containing a drawing of a blue button and the letter 'n' to its right. A yellow pencil is shown pointing to the shopping bag drawing.



Extensions and Adaptations

- ▶ Use other target final sound objects.
- ▶ Use initial or medial sound objects.

Name _____

P.017.SS

Letter Bag

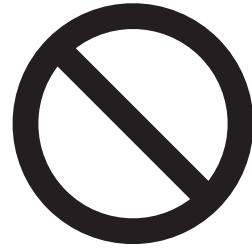



Letter-Sound Pyramid

Objective

The student will match final phonemes to graphemes.

Materials

- ▶ Letter-Sound Pyramid triangles (Activity Master P.018.AM1a - P.018.AM1b)
Note: There are two triangles marked "A" and "B."
- ▶ Final sound picture cards (Activity Master P.018.AM2a - P.018.AM2b)
- ▶ Game pieces (e.g., counters)

Activity

Students match final sounds of words to letters while playing a pyramid game.

1. Place final sound picture cards face down in a stack. Provide each student with a different triangle and game pieces.
2. Taking turns, students select the top card from the stack, name the picture and say its final sound (e.g., "shovel, /l/").
3. Look for letter on triangle that corresponds to final sound (i.e., "l").
4. If letter is found, place game piece on that spot and place picture card in a discard pile. If no letter is found which matches, place picture card at the bottom of the stack.
5. Continue until all matches are made.
6. Peer evaluation

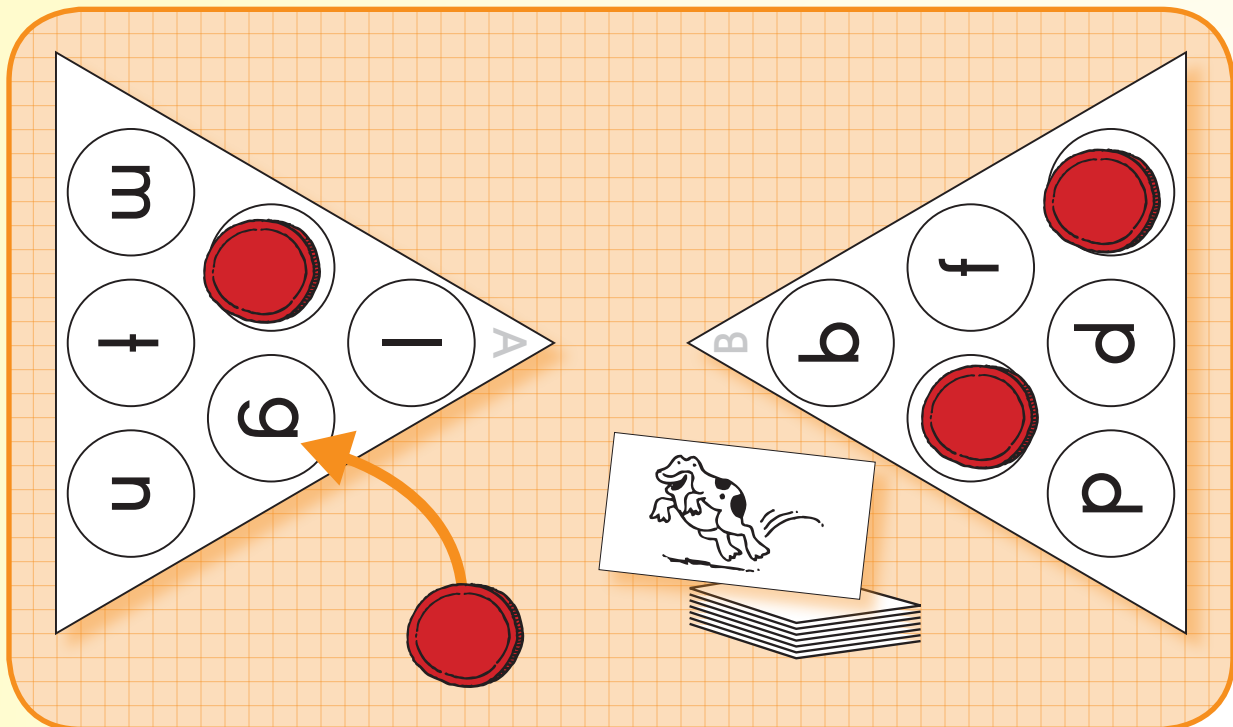

Extensions and Adaptations

- ▶ Use other triangles (Activity Master P.018.AM3a - P.018.AM3b) and picture cards (Activity Master P.018.AM4a - P.018.AM4b).
- ▶ Make other triangles (Activity Master P.018.AM5) for use with initial or medial sounds.

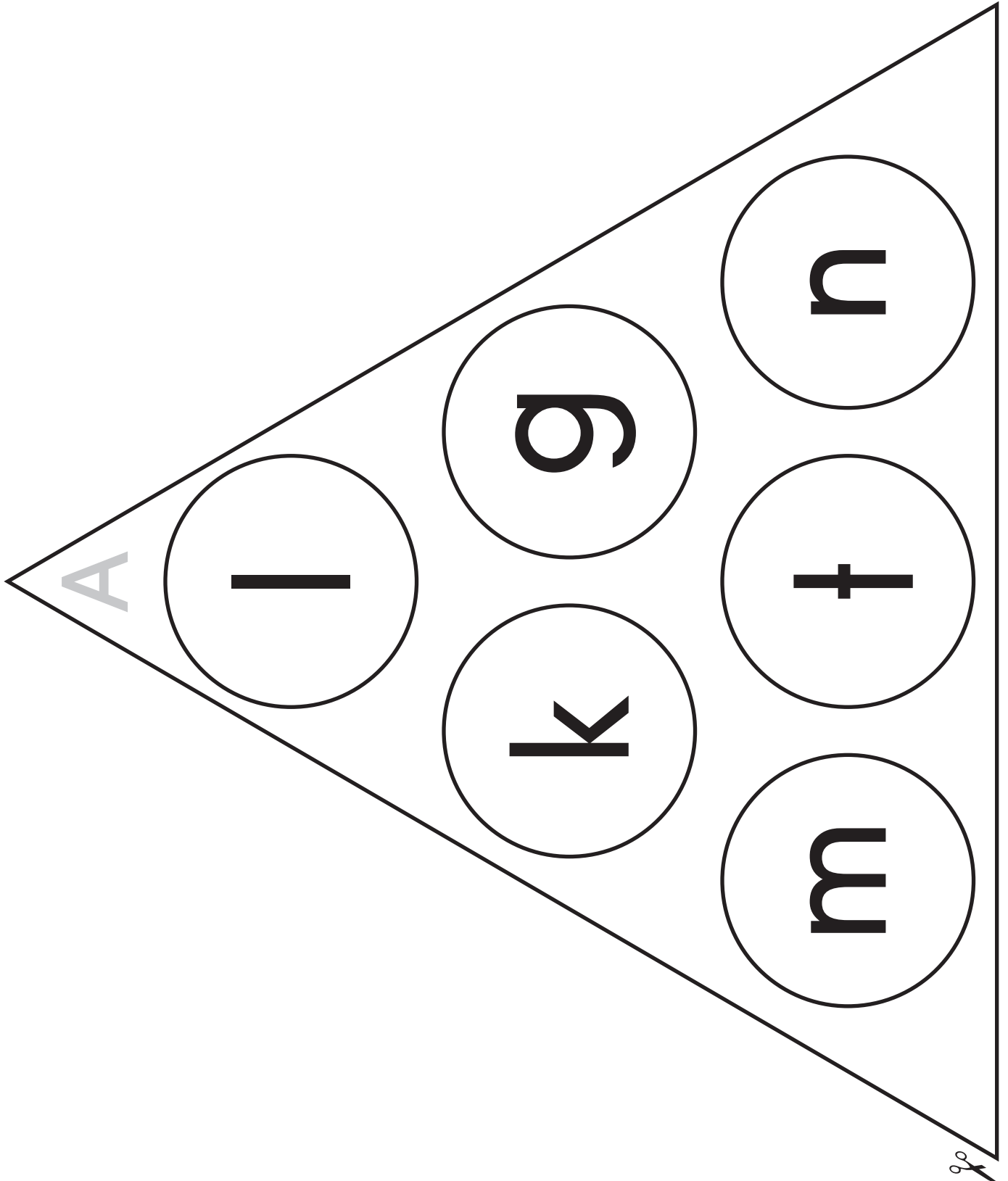

letter-sound triangle A

Phonics

Letter-Sound Pyramid

P.018.AM1b

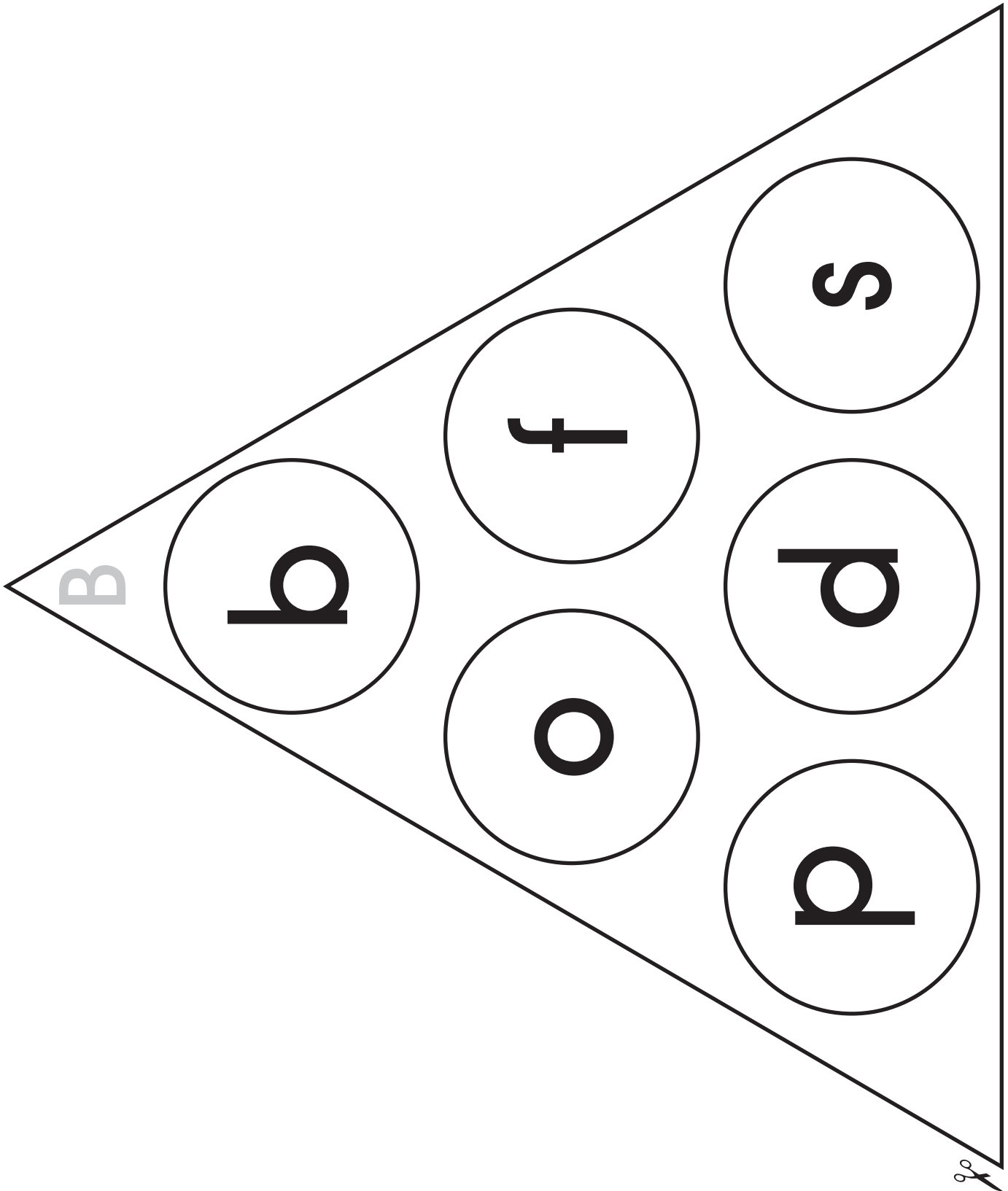

letter-sound triangle B

P.018.AM2a

Letter-Sound Pyramid

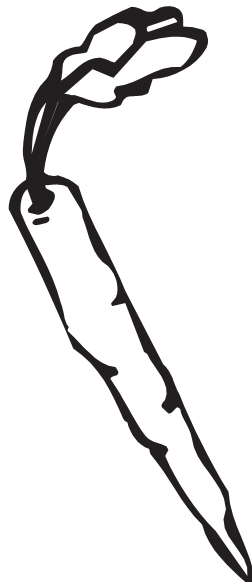
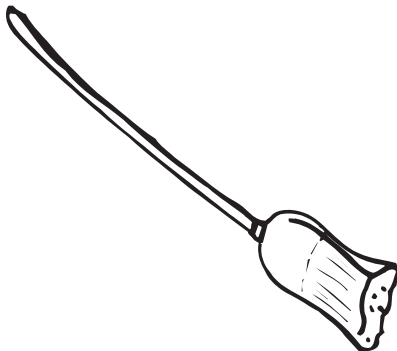
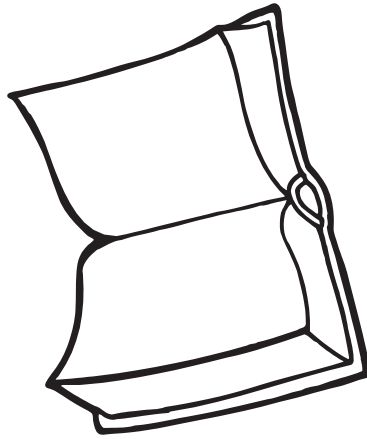

final sound picture cards: shovel, book, frog, broom, carrot, seven



Phonics

Letter-Sound Pyramid

P.018.AM2b

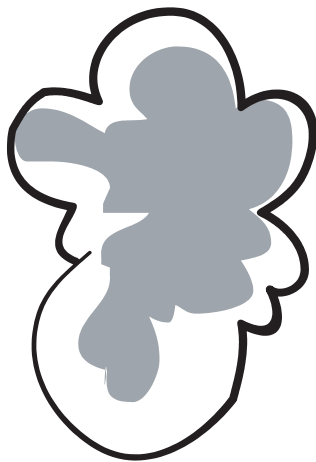
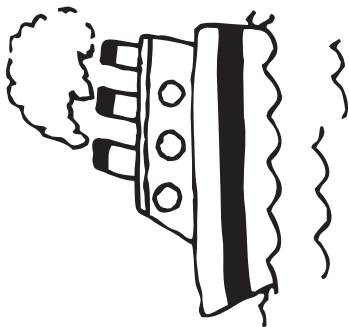
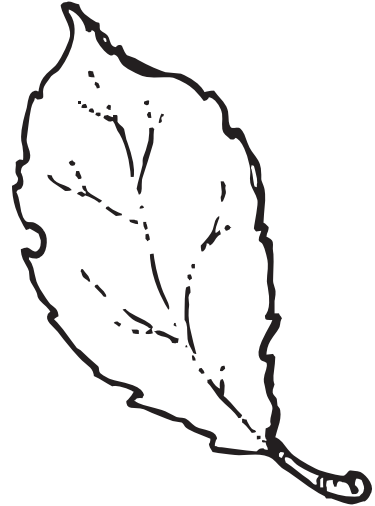
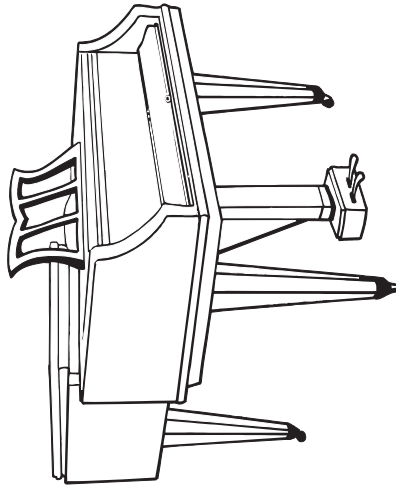
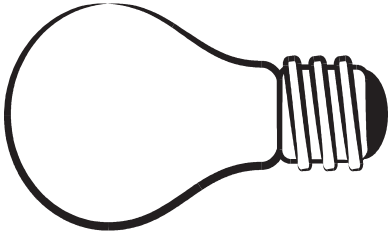

final sound picture cards: bulb, piano, leaf, ship, cloud, octopus



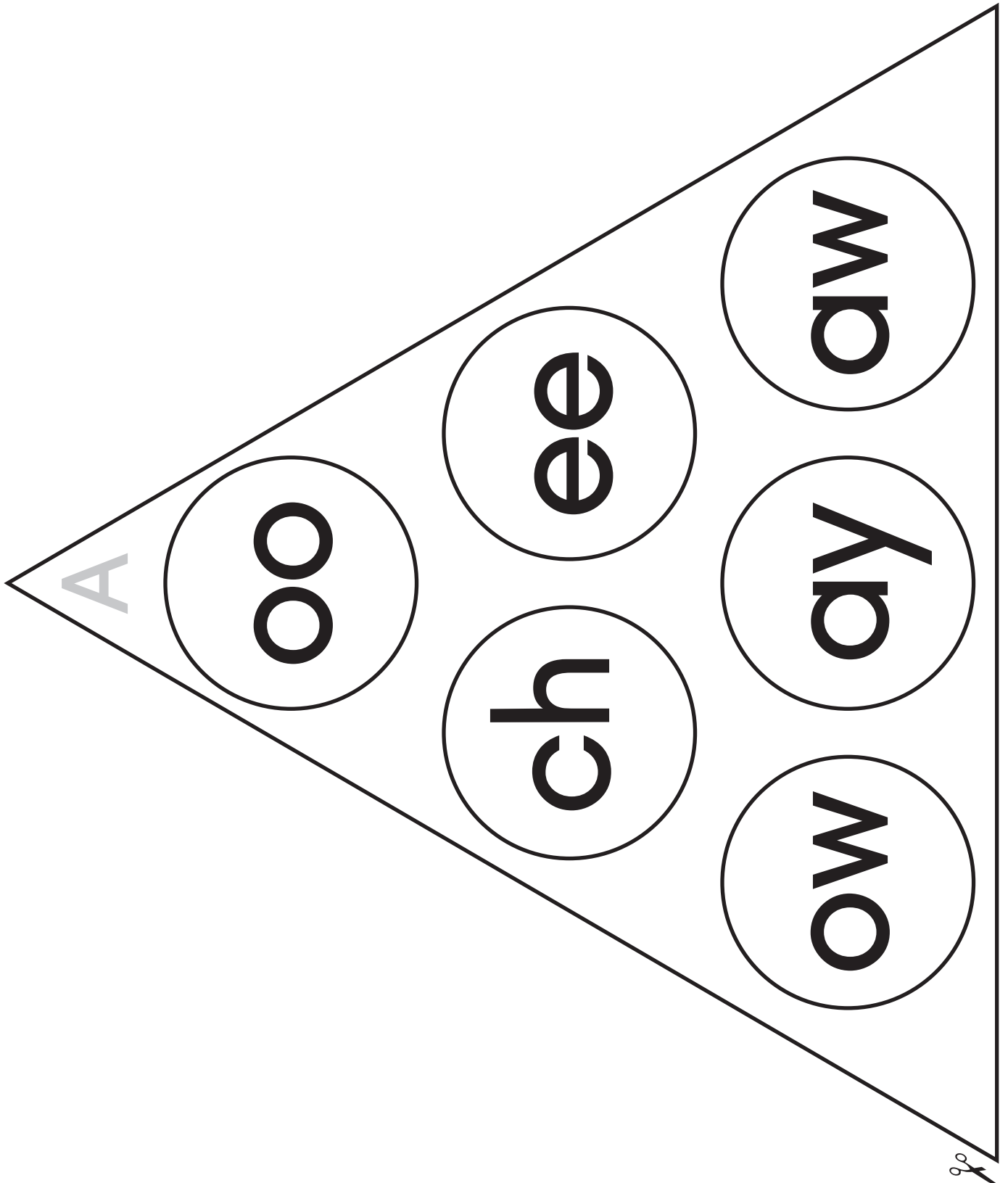

letter-sound triangle A

Phonics

Letter-Sound Pyramid

P.018.AM3b

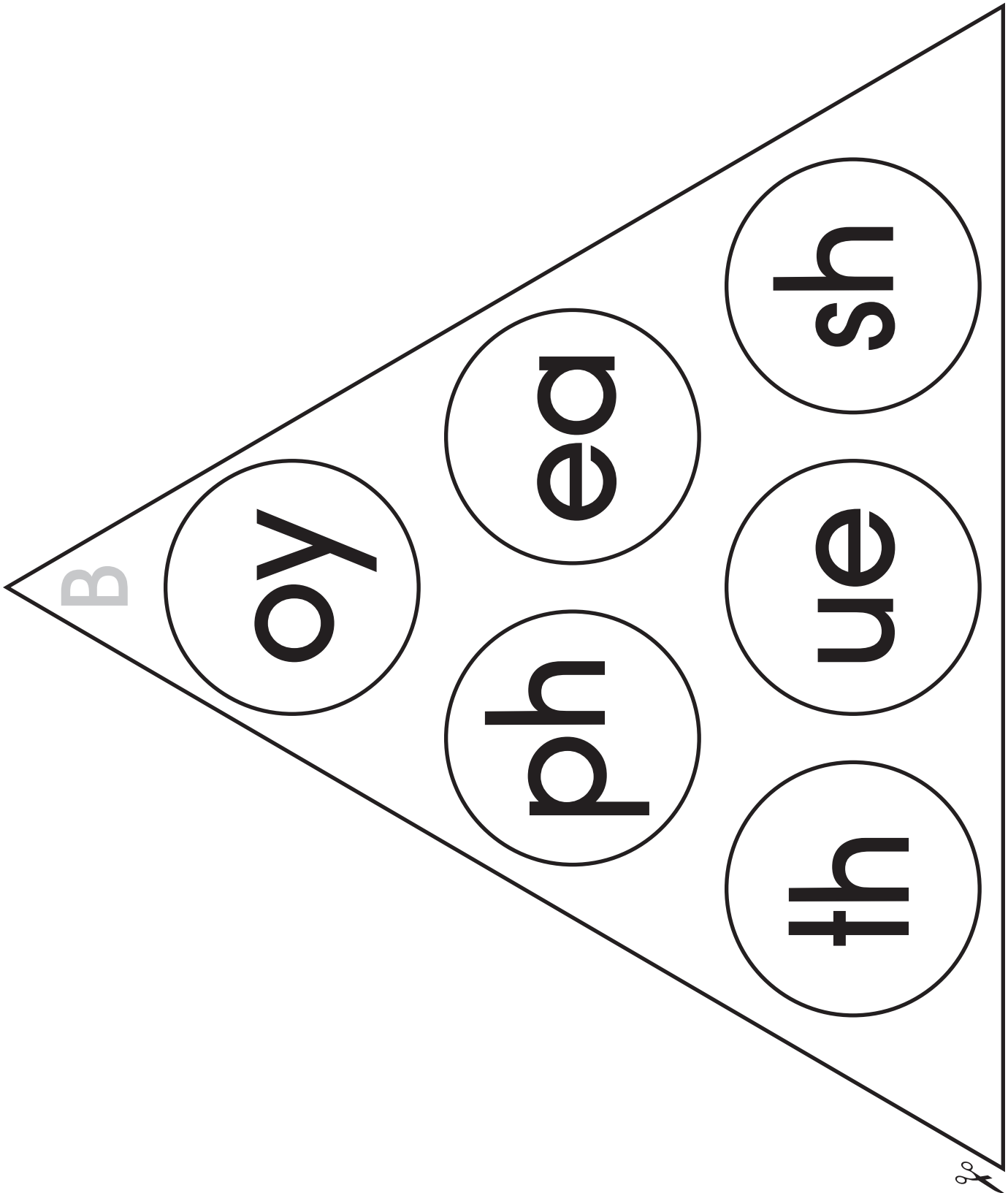

letter-sound triangle B

P.018.AM4a

Letter-Sound Pyramid

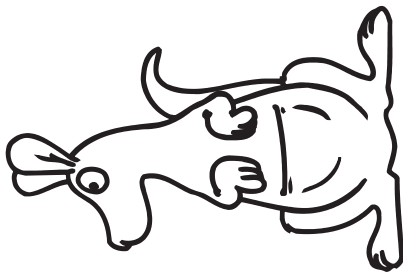
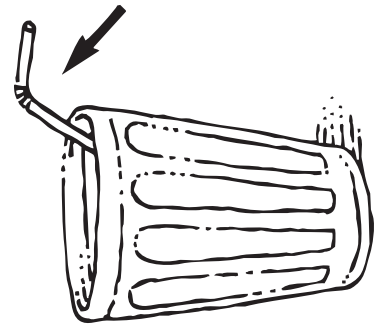
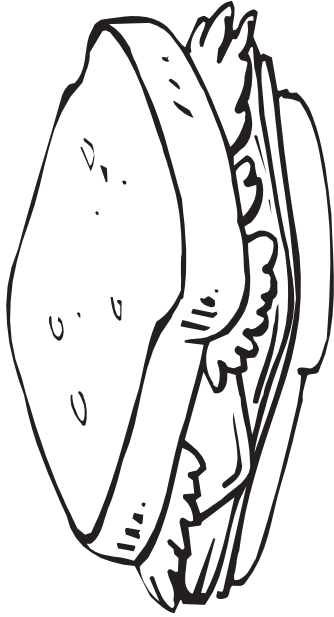

3

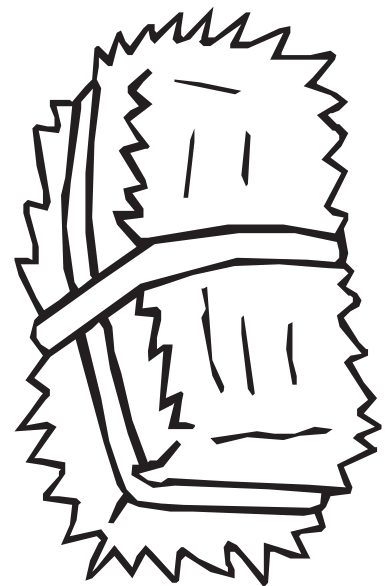

final sound picture cards: sandwich, cow, straw, kangaroo, three, hay



Phonics

Letter-Sound Pyramid

P.018.AM4b

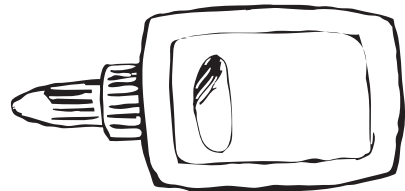
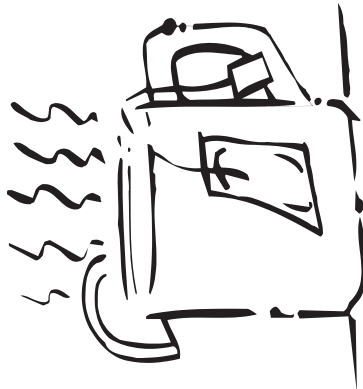
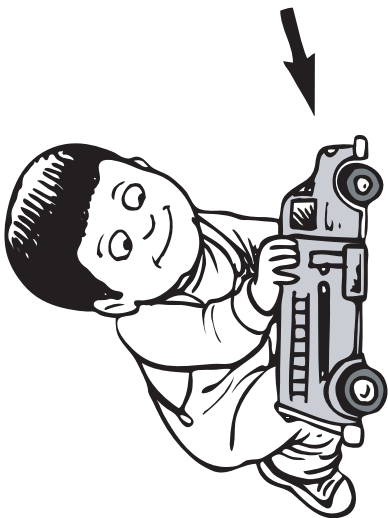
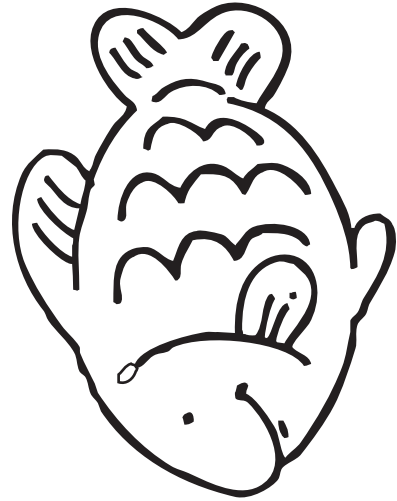
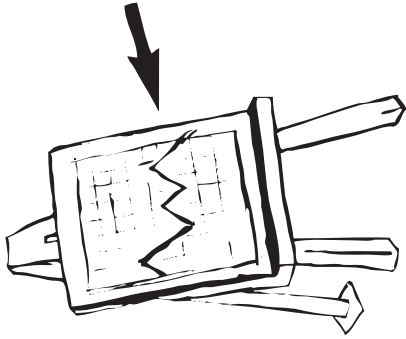

final sound picture cards: graph, tooth, fish, toy, tea, glue



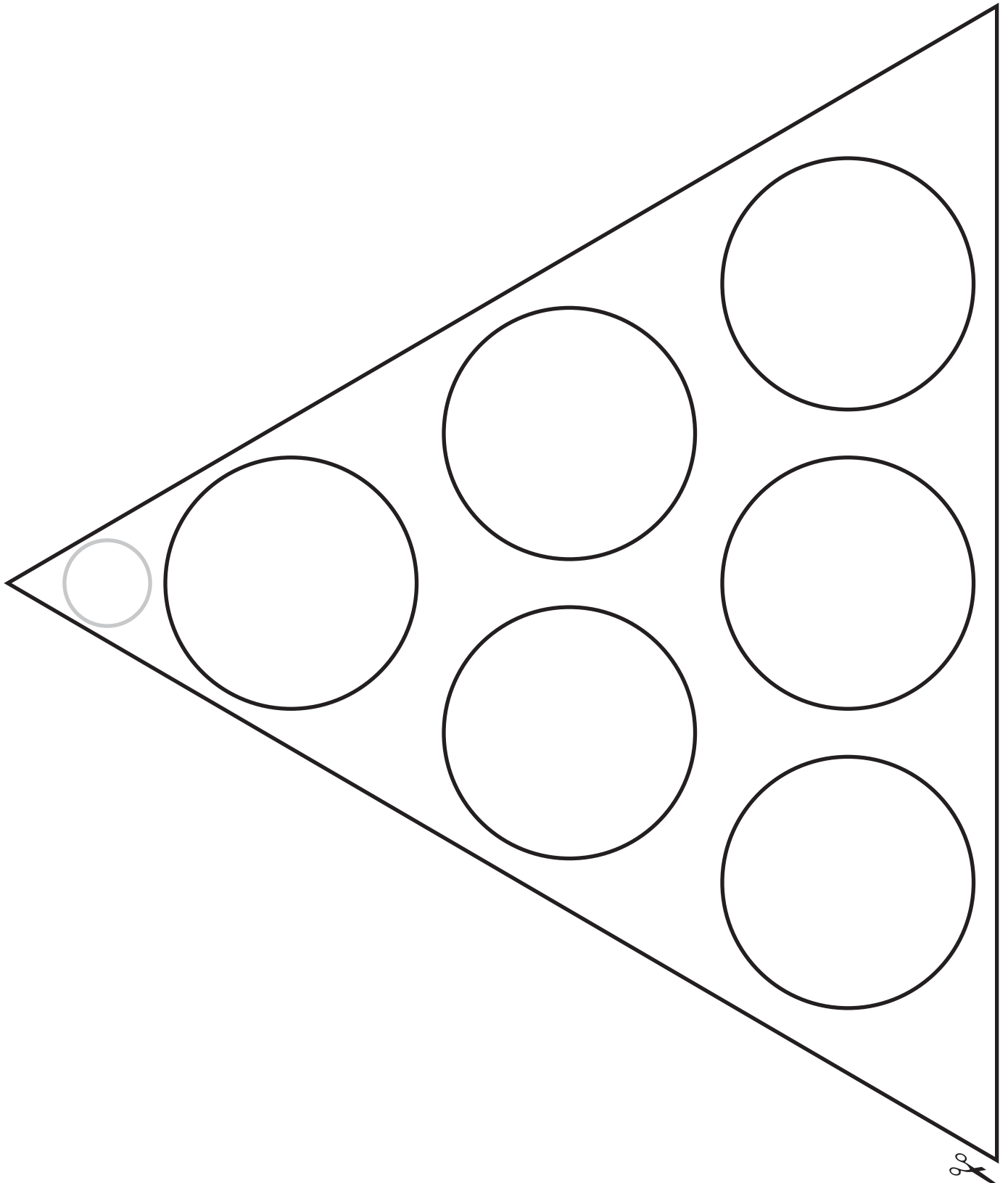

blank triangle



Letter-Sound Folder Sort

Objective

The student will match final phonemes to graphemes.

Materials

- ▶ Letter/letter combination cards (Activity Master P.019.AM1a - P.019.AM1b)
Choose four target letters or letter combination cards.
- ▶ File folder
Tape or glue target cards horizontally across the top of the file folder.
- ▶ Final sound picture cards (Activity Master P.LSC-F.1 - P.LSC-F.16)
Choose picture cards that correspond to target letters.

Activity

Students sort final sound picture cards to letters on a file folder.

1. Place the open file folder on a flat surface. Place the final sound picture cards face up in a stack next to the file folder.
2. Taking turns, students select a card, name the picture, and say its final sound (e.g., “crib, /b/”).
3. Look for letter(s) on folder that corresponds to final sound, name it (i.e., “b”), and place the final sound picture card below that letter(s).
4. Continue until all cards are sorted.
5. Peer evaluation

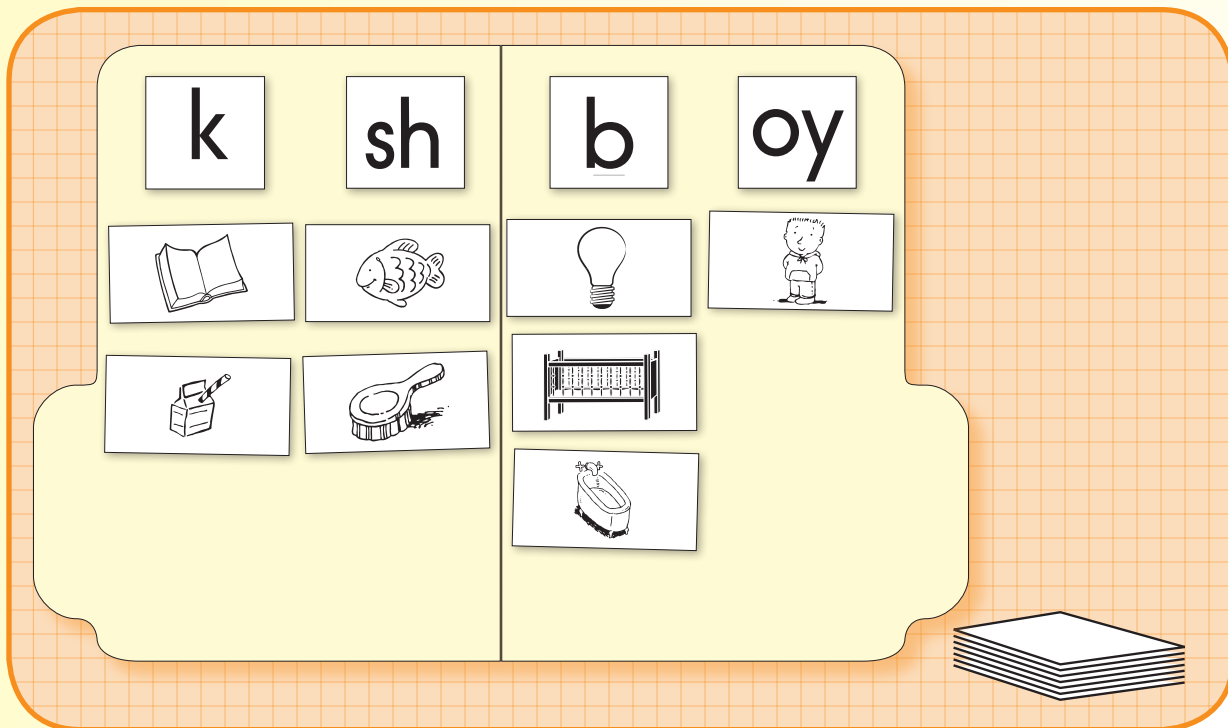

Extensions and Adaptations

- ▶ Use other target letter(s).
- ▶ Sort initial or medial sounds (Activity Master P.LSC-I.1 - P.LSC-I.22 or P.LSC-M.1 - P.LSC-M.13).

b

d

f

g

k

l

m

n

o

p

s

t

letter/letter combination cards



Phonics

Letter-Sound Folder Sort

P.019.AM1b

x

ar

sh

th

ch

ng

ow

aw

oo

oy

letter/letter combination cards





Objective

The student will match medial phonemes to graphemes.

Materials

- ▶ Letter-Sound Train engine and caboose (Activity Master P.020.AM1)
- ▶ Letter-Sound Train cars (Activity Master P.020.AM2)
Copy six times.
- ▶ Construction paper
Use as the platform.
- ▶ Index card
Label the card with the letter “i”.
Attach it to the train engine.
- ▶ Medial sound picture cards (Activity Master P.020.AM3a - P.020.AM3c)

Activity

Students match medial sounds in words to the target letter on a train.

1. Place the engine, cars, and caboose in a line on a flat surface. Place medial sound picture cards face down in a stack. Place the platform at the center.
2. Taking turns, students select the top card, name it, and say its medial sound (e.g., “duck, /u/”). State the letter that makes that sound (i.e., “u”).
3. Determine if medial sound matches target letter. If it matches, place card on a train car. If it does not match, place on the platform.
4. Continue until all cards are sorted.
5. Peer evaluation

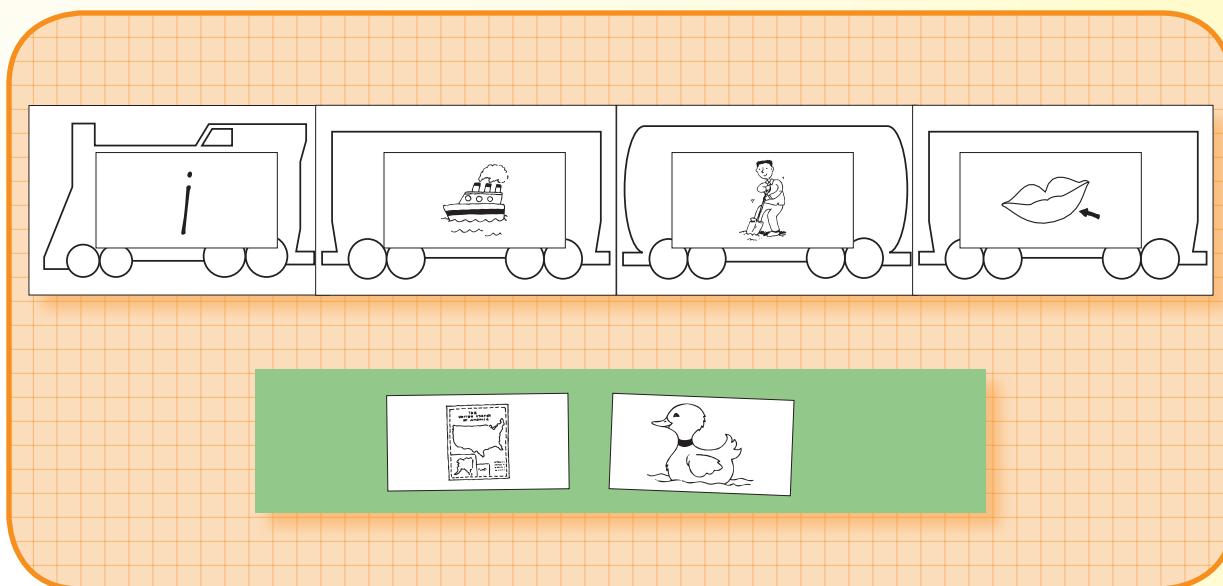

Extensions and Adaptations

- ▶ Use other target medial sound cards (Activity Master P.LSC-M.1 - P.LSC-M.13).
- ▶ Use target and non-target initial or final objects or sound picture cards (Activity Master P.LSC-I.1 - P.LSC-I.22 or P.LSC-F.1 - P.LSC-F.16).

Phonics

Letter-Sound Train

P.020.AMI

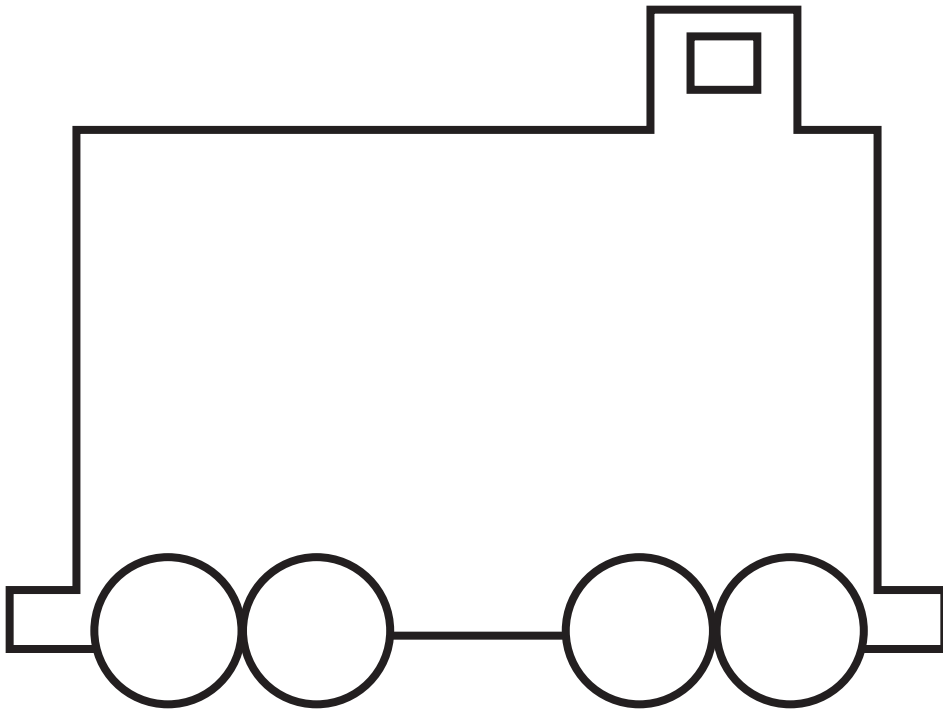
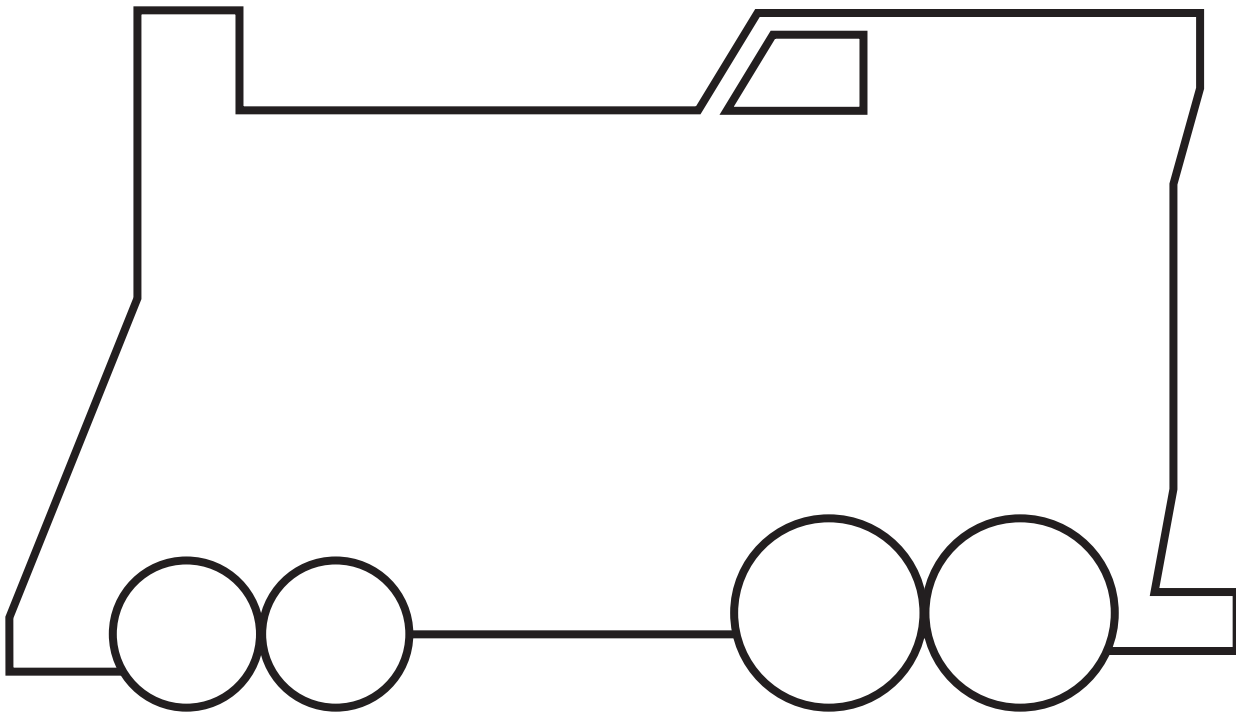

letter-sound train engine and caboose



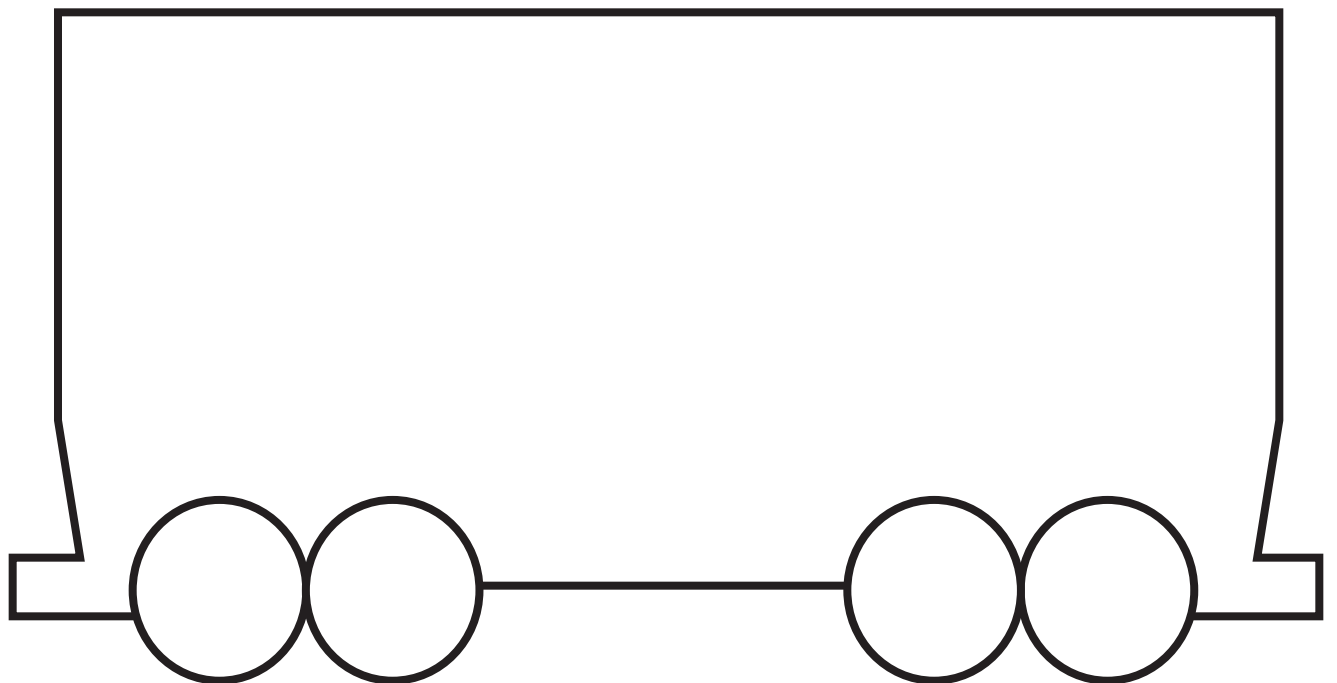
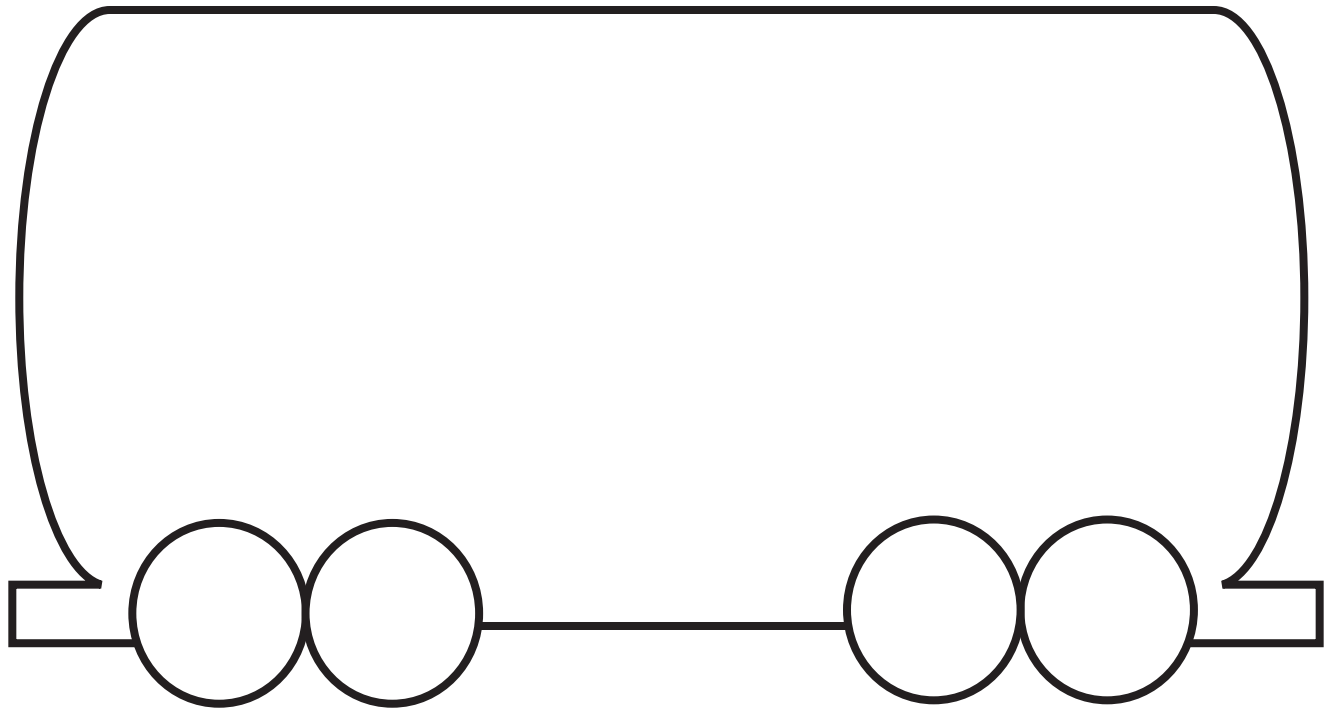

letter-sound train cars



Phonics

Letter-Sound Train

P.020.AM3a

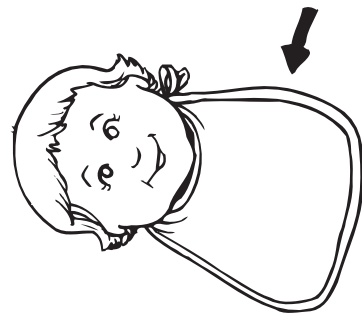
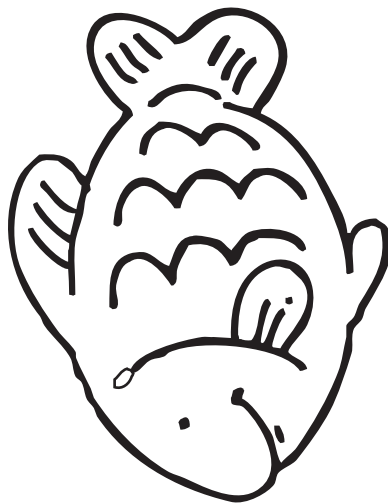
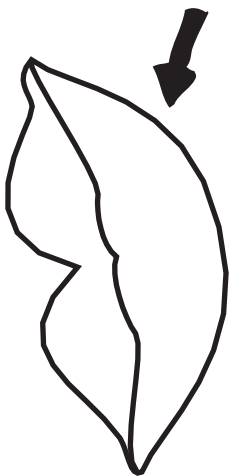
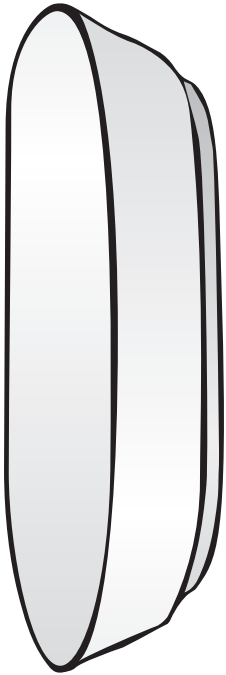

medial sound picture cards: dish, kiss, pig, lip, fish, bib



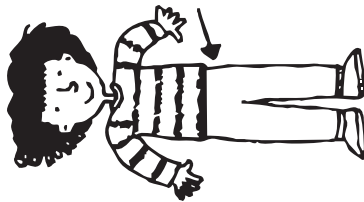
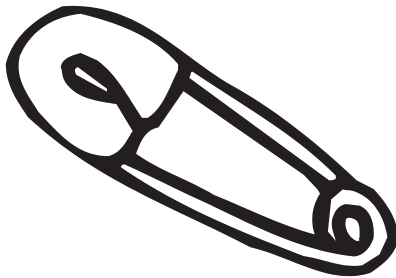
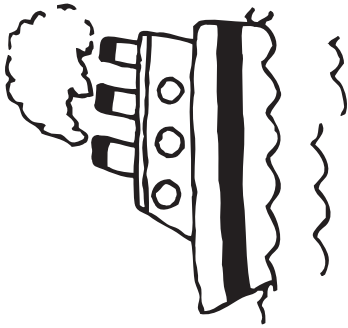

medial sound picture cards: ship, six, dig, pin, hip, clip



Phonics

Letter-Sound Train

P.020.AM3c

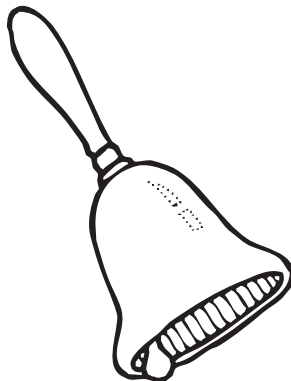
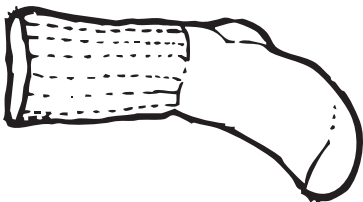
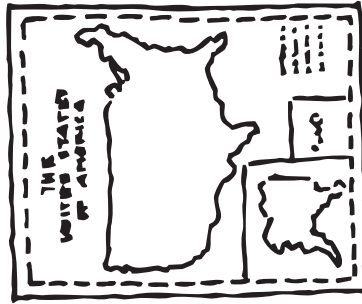

medial sound picture cards: duck, map, gate, sock, bell, mice





Objective

The student will match medial phonemes to graphemes.

Materials

- ▶ Vowel letter cards (Activity Master P.021.AM1)
Choose three target letter cards and punch a hole in the top center of each.
- ▶ Medial sound picture cards (Activity Master P.021.AM2a - P.021.AM2e)
Choose picture cards that correspond to target letters and punch a hole in the top and bottom of each.
- ▶ Clothes hanger
- ▶ String, yarn, or clear fishing line

Activity

Students sort medial sound picture cards to letters while making a mobile.

1. Place vowel letter cards at the center. Place medial sound picture cards face up in a stack. Provide the student with a clothes hanger and string.
2. The student ties the letter cards across the clothes hanger while saying the name and sound of each.
3. Selects a medial sound picture card, names the picture, and says its medial sound (e.g., “well, /e/”).
4. Looks for the letter on hanger that corresponds to the medial sound, names it (i.e., “e”), and places it below that letter.
5. Continues until all cards are sorted. Ties each card under the corresponding letter.
6. Teacher evaluation

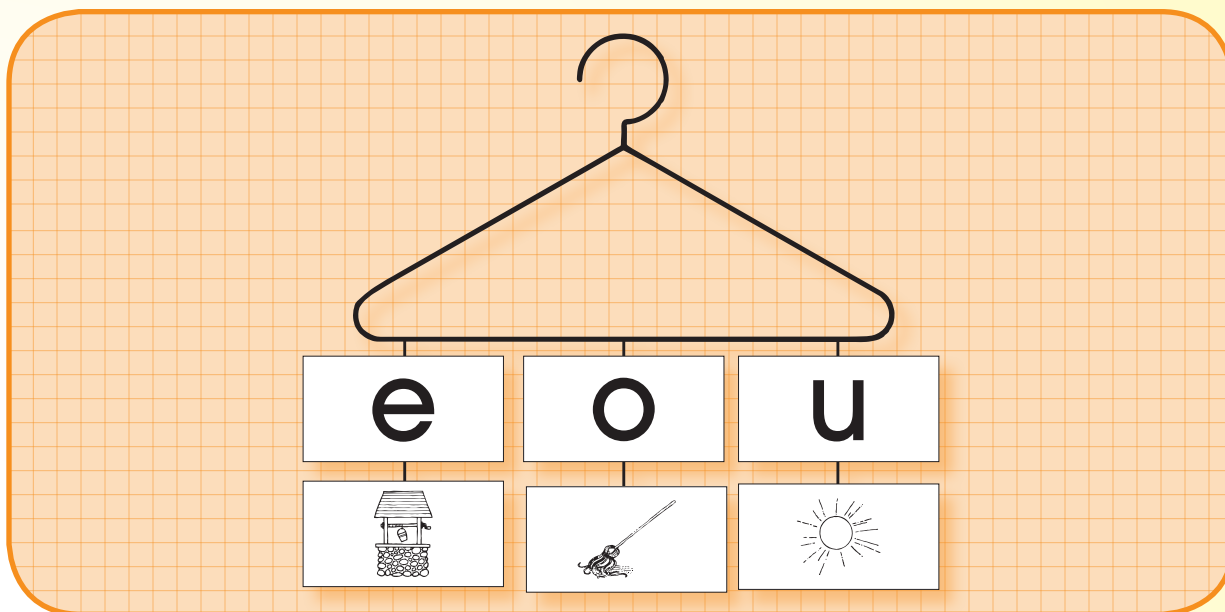

Extensions and Adaptations

- ▶ Use other target letters.
- ▶ Sort initial or final sounds (Activity Master P.LSC-I.1 - P.LSC-I.22 or P.LSC-F.1- P.LSC-F.16).

Phonics

Letter-Sound Mobile

P.021.AMI

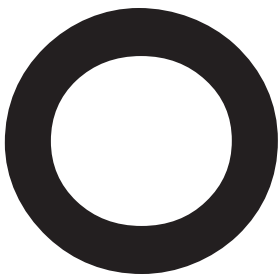
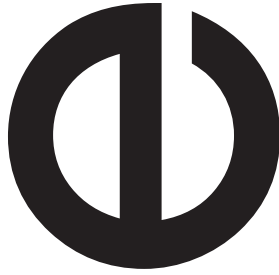

vowel letter cards



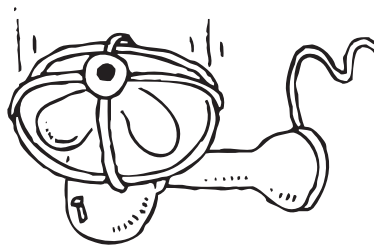
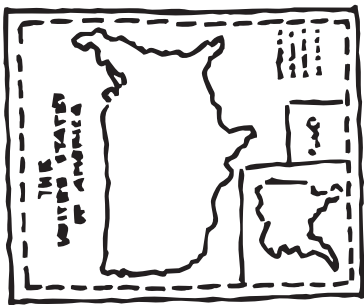
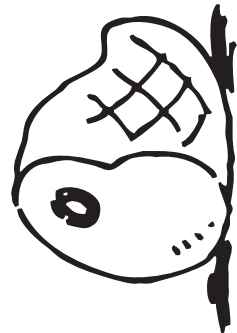

medial sound picture cards: hat, cat, ham, map, fan



Phonics

Letter-Sound Mobile

P.021.AM2b

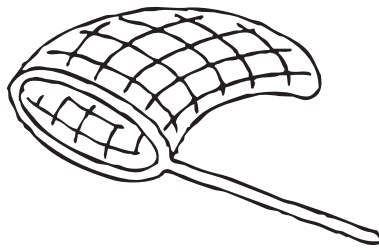
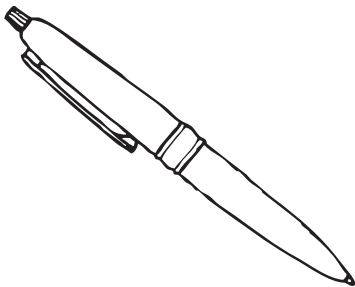
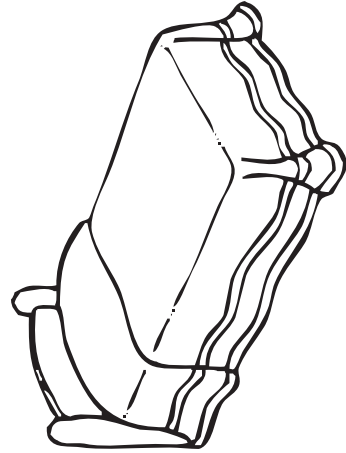
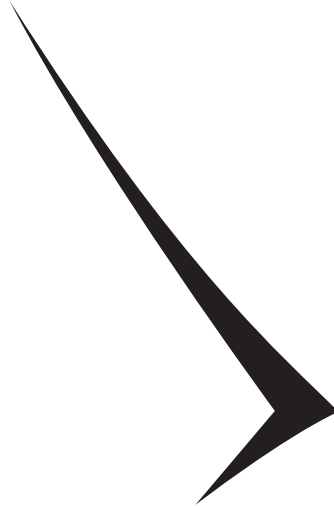
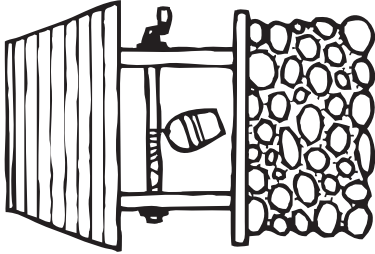

medial sound picture cards: well, check, bed, pen, net



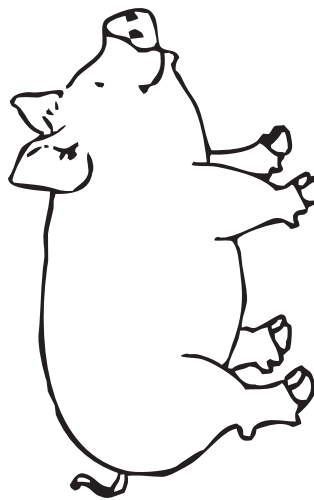
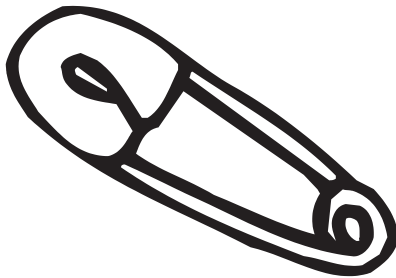
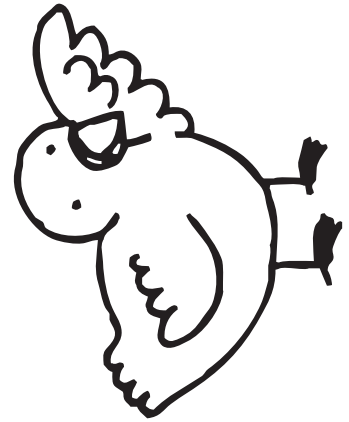
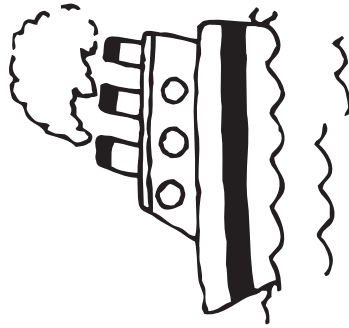
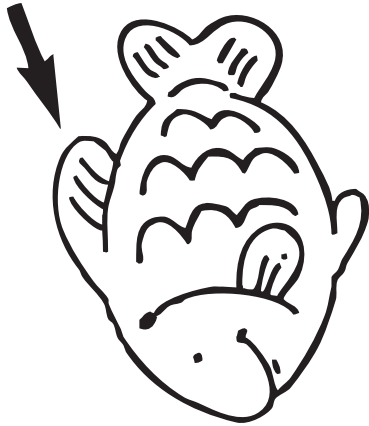

medial sound picture cards: fin, ship, chick, pin, pig



Phonics

Letter-Sound Mobile

P.021.AM2d

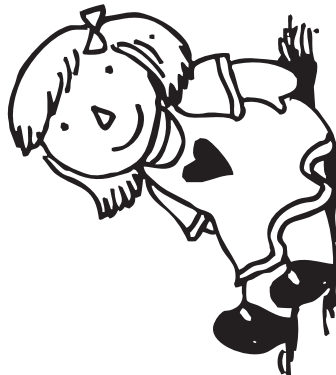
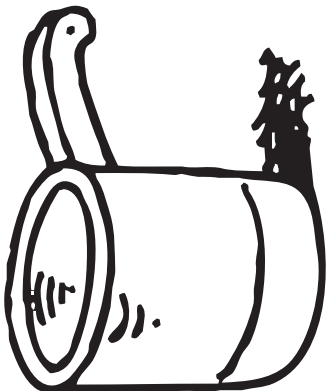
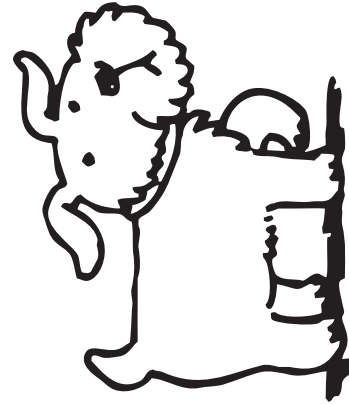
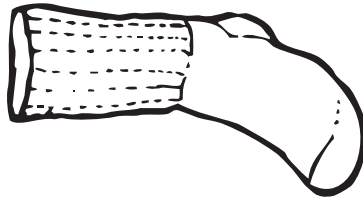
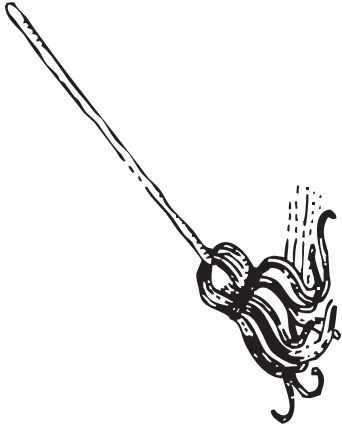

medial sound picture cards: mop, sock, dog, pot, doll



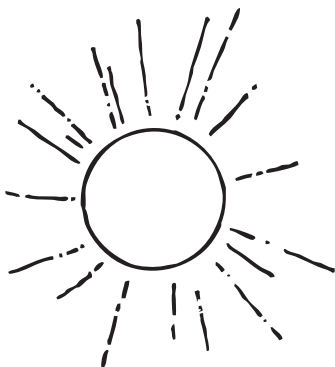
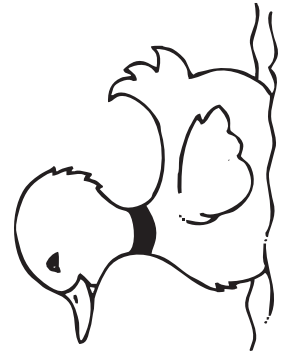
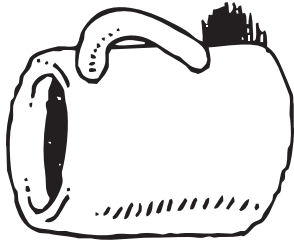

medial sound picture cards: mug, gum, duck, sun, rug



Letter-Sound Bingo

Objective

The student will match medial phonemes to graphemes.

Materials

- ▶ Letter-sound bingo cards (Activity Master P.022.AM1a - P.022.AM1c)
- ▶ Medial sound picture cards (Activity Master P.022.AM2a - P.022.AM2d)
- ▶ Game pieces (e.g., counters)

Activity

Students match medial sounds of words to letters while playing a Bingo-type game.

1. Place the medial sound picture cards face down in a stack. Provide each student with a different bingo card and game pieces.
2. Taking turns, student one selects the top card from the stack, names the picture, and says its medial sound (e.g., “lock, /o/”).
3. Each student looks for letter on his bingo card that corresponds to the medial sound (i.e., “o”) and places one game piece on that letter.
4. Student one places picture card in a discard pile.
5. Continue until one student has a completed card and says, “Bingo!”
6. Peer evaluation

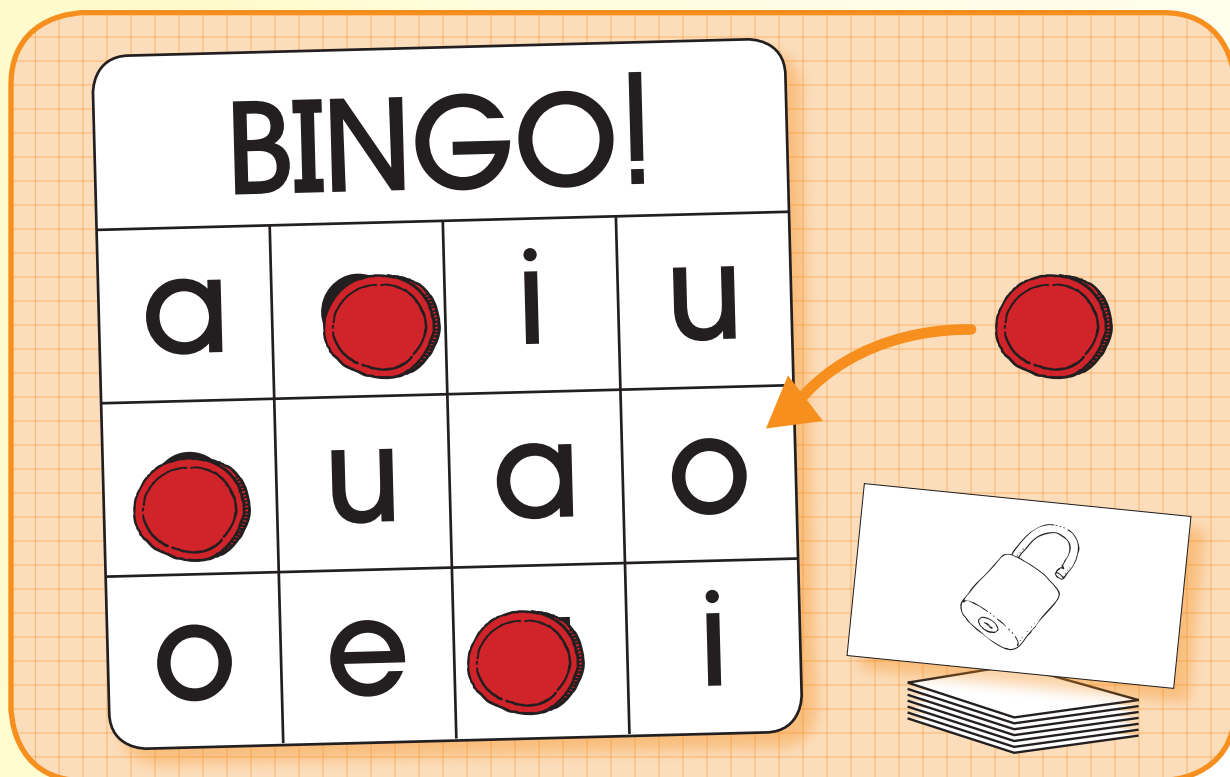

Extensions and Adaptations

- ▶ Make other bingo cards (Activity Master P.022.AM3) for use with initial or final sounds.

BINGO!

a

o

i

u

e

u

a

o

o

e

u

i



BINGO!

o

u

a

i

e

i

e

a

u

o

i

e



BINGO!

a

u

o

i

o

i

e

a

u

a

i

e



Phonics

Letter-Sound Bingo

P.022.AM2a

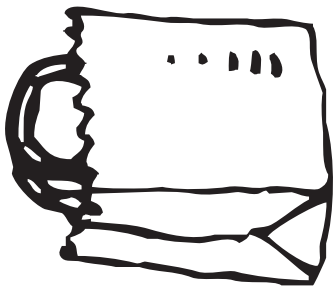
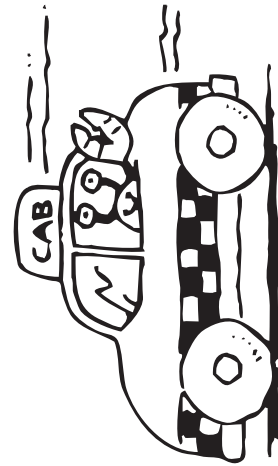
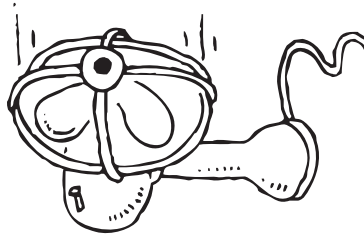
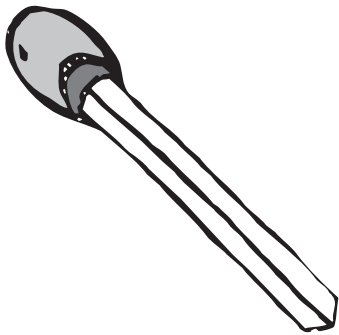

medial sound picture cards: match, fan, cab, bag, bat, check



10

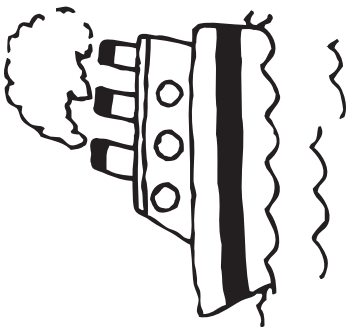
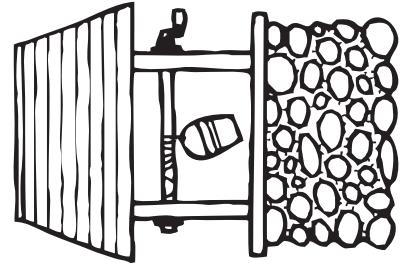
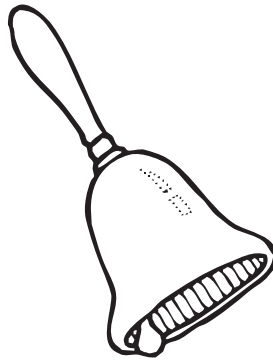

6

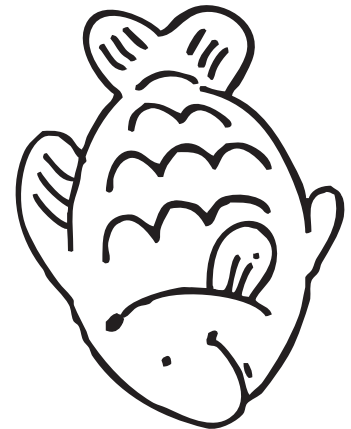

medial sound picture cards: ten, bell, well, ship, six, fish



Phonics

Letter-Sound Bingo

P.022.AM2c

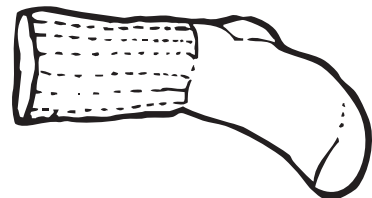
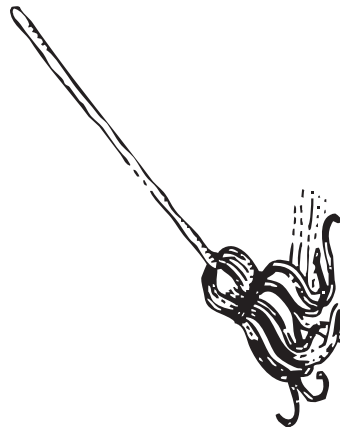
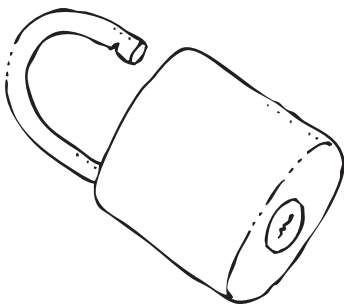
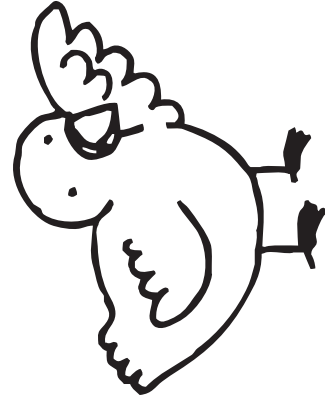
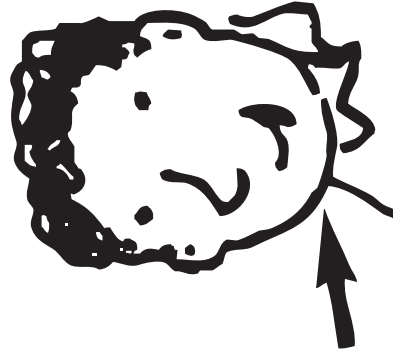
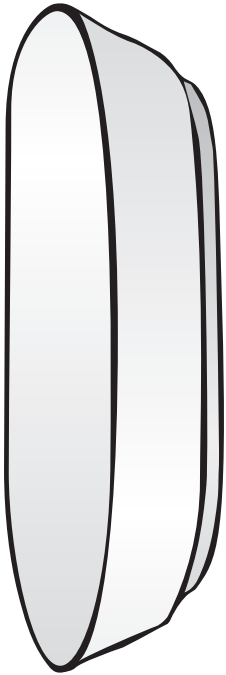

medial sound picture cards: dish, chin, chick, lock, mop, sock



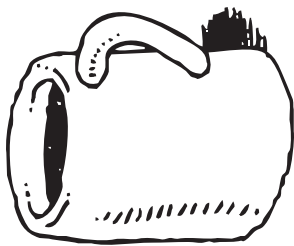

medial sound picture cards: hop, thumb, bus, mug, duck, rug



BINGO!





P.023

Letter-Sound Correspondence

Medial Phoneme Spin

Objective

The student will match medial phonemes to graphemes.

Materials

- ▶ Vowel spinner (Activity Master P.023.AM1)
Copy on card stock, laminate, and cut.
- ▶ Brad
Attach arrow to the spinner with the brad.
- ▶ Medial sound picture cards (Activity Master P.023.AM2a - P.023.AM2d)

Activity

Students match medial sounds of words to letters while playing a spinner game.

1. Place spinner at the center. Place picture cards face up in rows.
2. Taking turns, students spin the spinner, name the letter, and say its sound (e.g., “u, /u/”).
3. Select picture card that has the same medial sound, name it, and say its medial sound (e.g., “duck, /u/”). If correct, keep the card. If not correct, return card to its original position.
4. Continue until all cards are used.
5. Peer evaluation

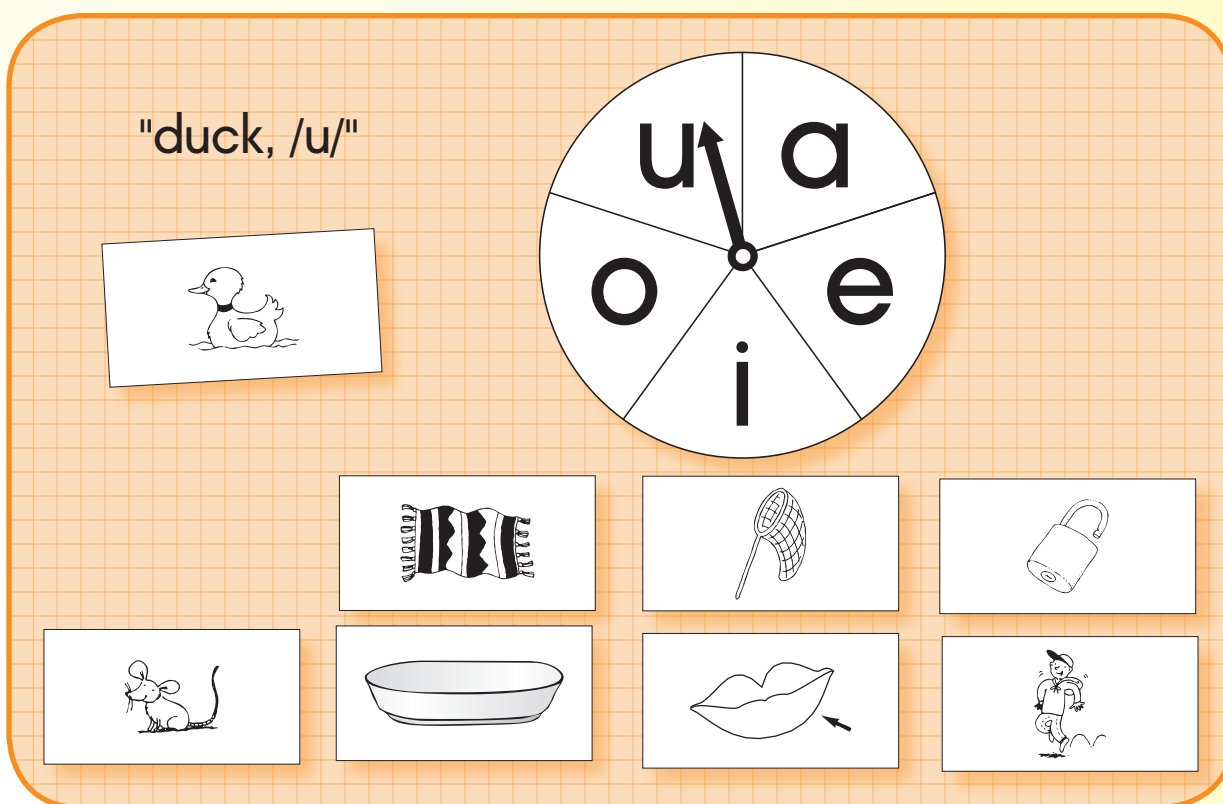

"duck, /u/"

u a

o e i

Scarf, Net, Padlock, Mouse, Bowl, Lips, Boy with ball

Extensions and Adaptations

- ▶ Make another spinner (Activity Master P.023.AM3) for use with initial or final sounds.
- ▶ Use long vowels as target letters.

Phonics

Medial Phoneme Spin

P.023.AMI

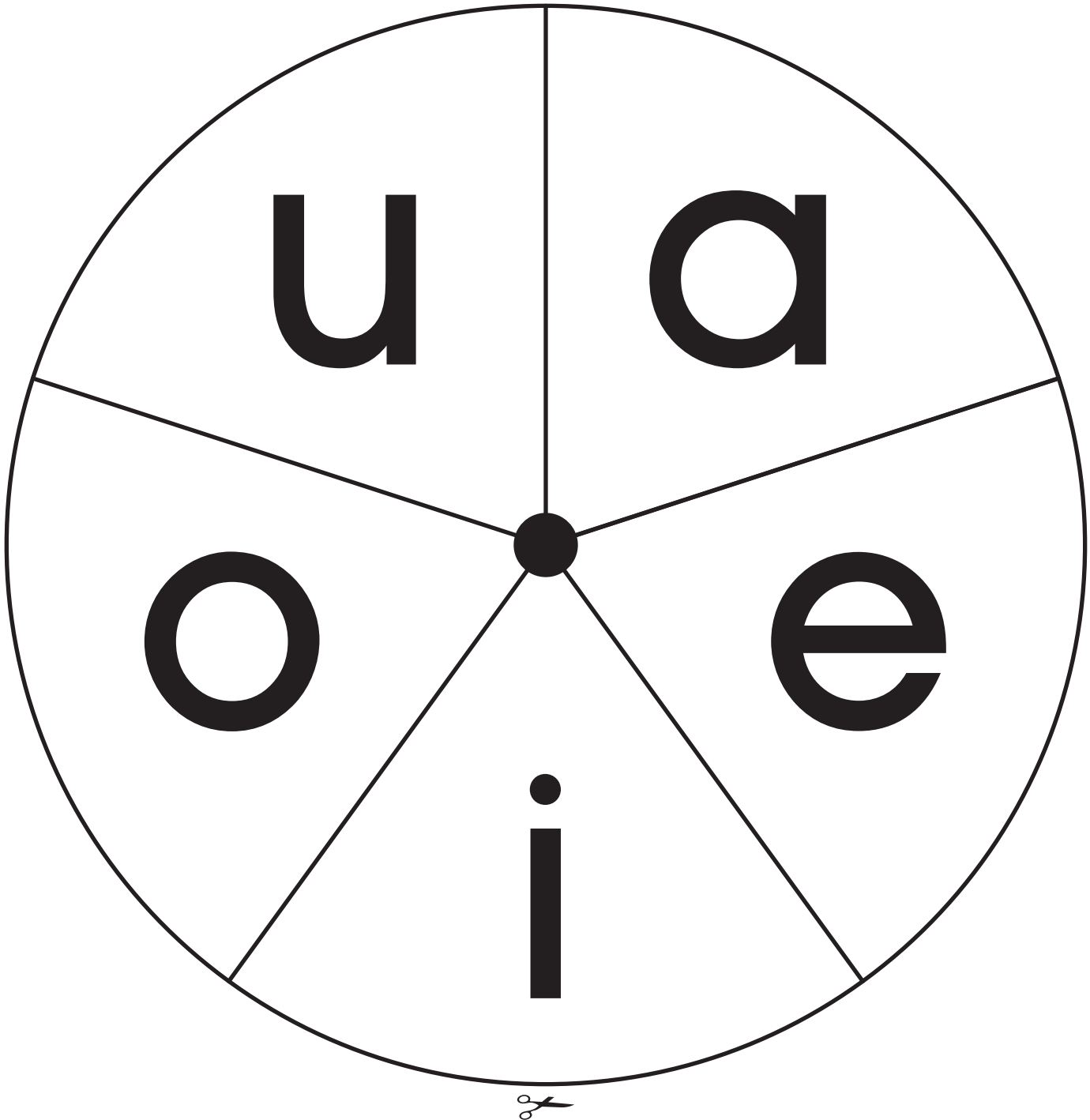

vowel spinner

P.023.AM2a

Medial Phoneme Spin

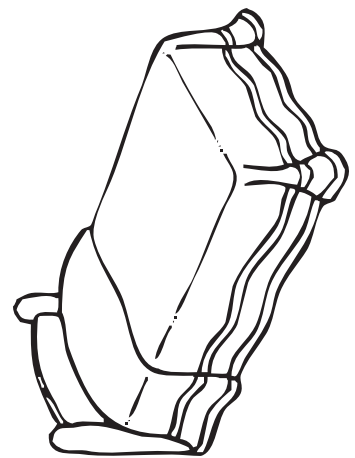
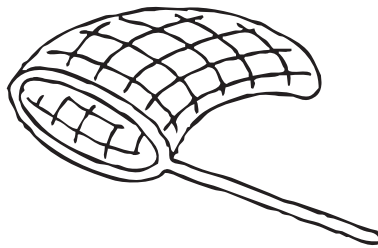
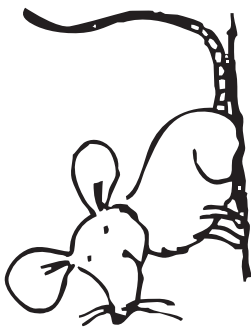
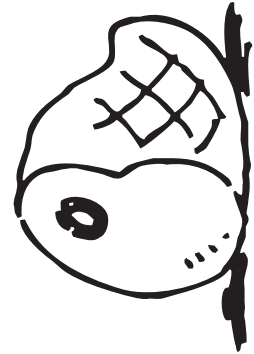
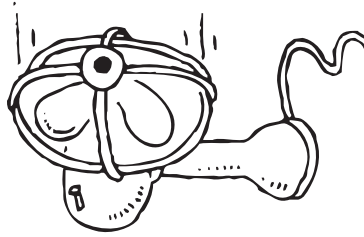
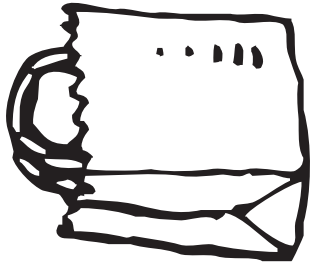

medial sound picture cards: bag, fan, ham, rat, net, bed



Phonics

Medial Phoneme Spin

P.023.AM2b

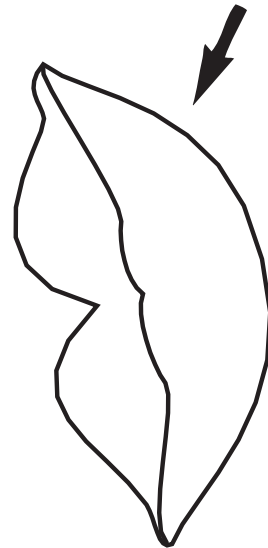
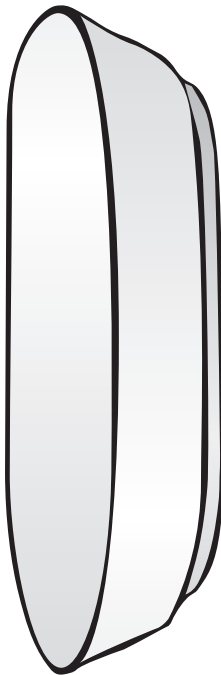
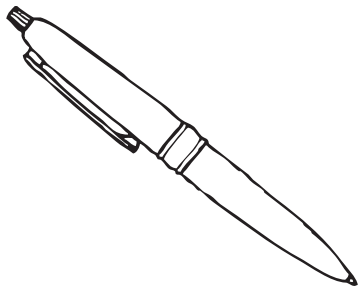
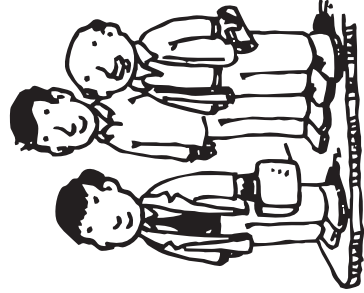
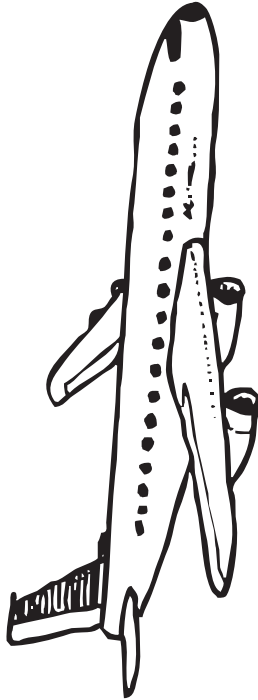
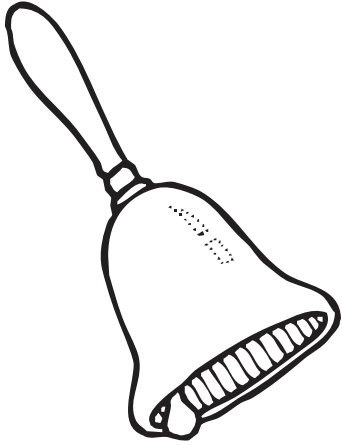

medial sound picture cards: bell, jet, men, pen, dish, lip



P.023.AM2c

Medial Phoneme Spin

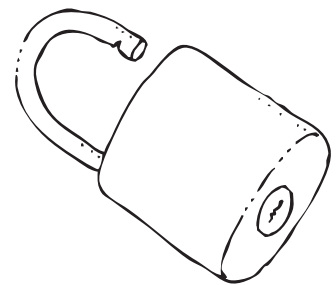
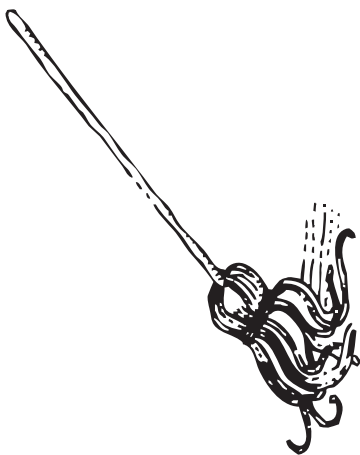
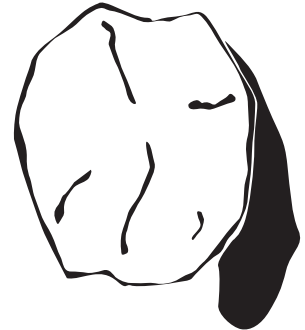
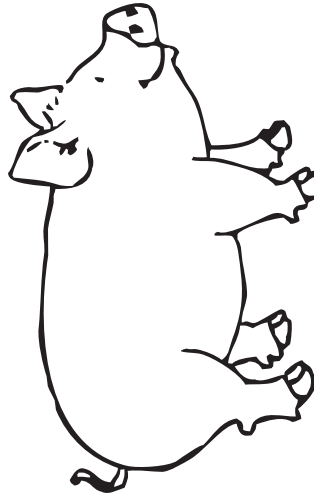
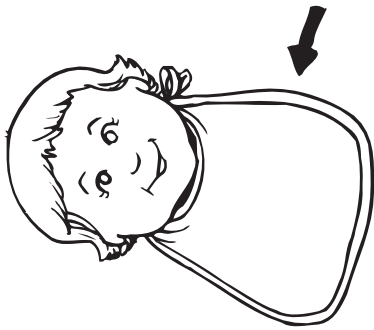

medial sound picture cards: bib, pig, rock, mop, hop, lock



Phonics

Medial Phoneme Spin

P.023.AM2d

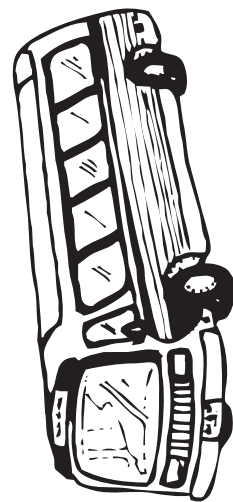
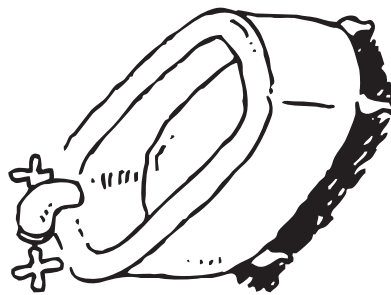
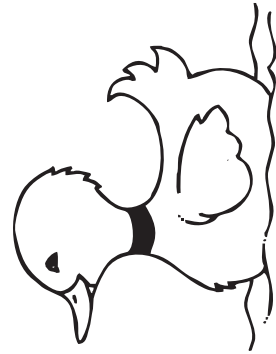
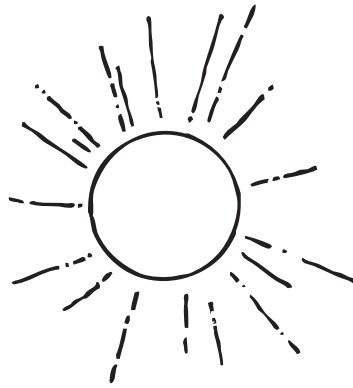

medial sound picture cards: fox, sun, duck, rug, tub, bus



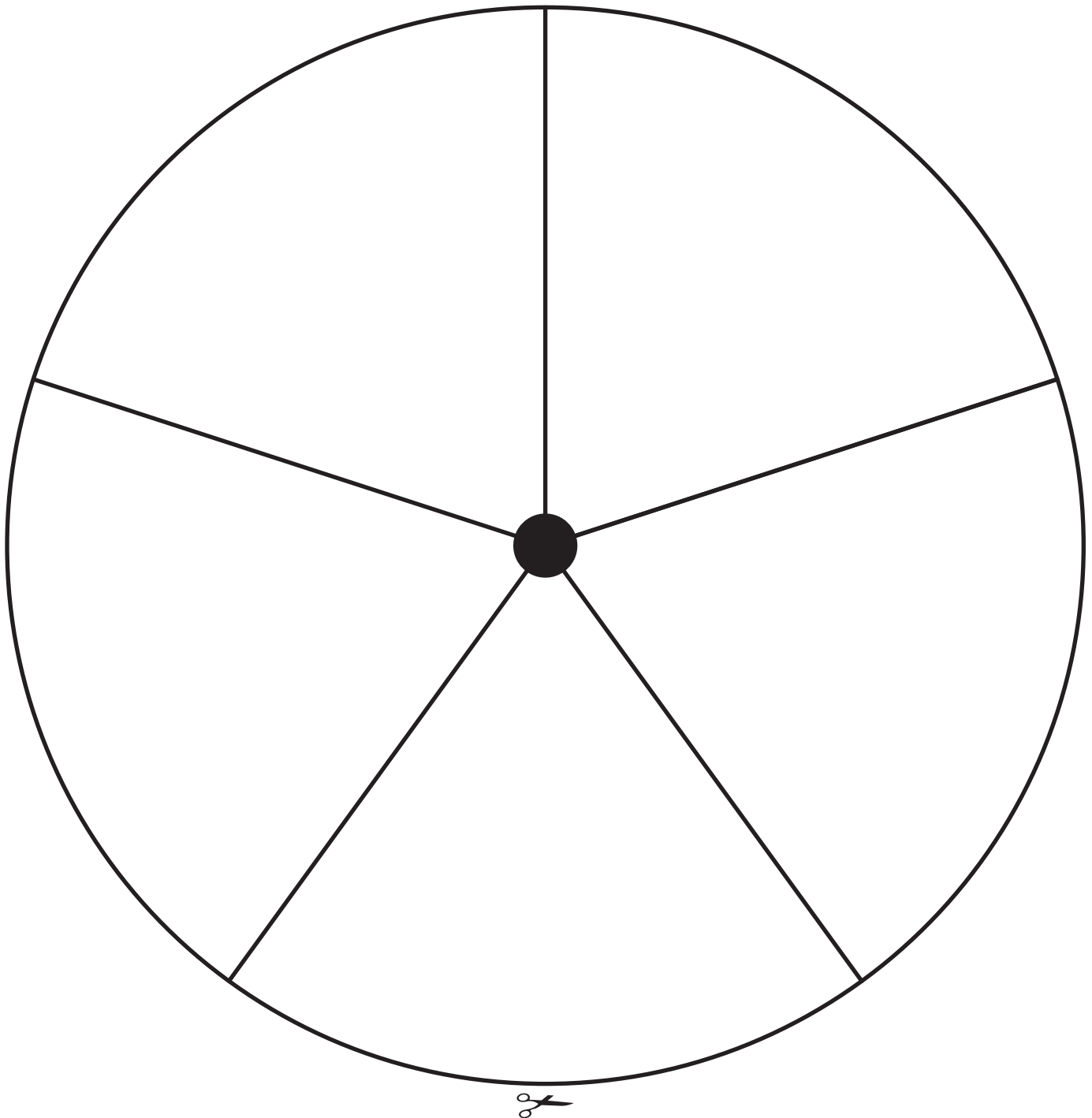

blank spinner

Where's That Sound?

Objective

The student will match initial and final phonemes to graphemes.

Materials

- ▶ Initial and final sound train cards (Activity Master P.024.AM1)
- ▶ Letter cards (Activity Master P.007.AM1a - P.007.AM1i)
Choose target letter(s).
- ▶ Initial and final sound picture cards (Activity Master P.LSC-I.1 - P.LSC-I.22 and P.LSC-F.1 - P.LSC-F.16)
Choose cards that match the target letter(s).

Activity

Students determine the position of the target sound in words and sort.

1. Place the initial sound train card, target letter card, and final sound train card left to right in a row. Place the picture cards face down in a stack.
2. Taking turns, students name the target letter and say its sound (e.g., “s, /s/”). Select a picture card, name it, and determine if the target sound is at the beginning or end of the word (e.g., “sandwich. I hear the /s/ at the beginning of the word”).
3. Place the card under the corresponding train card.
4. Continue until all cards in the stack are sorted.
5. Peer evaluation

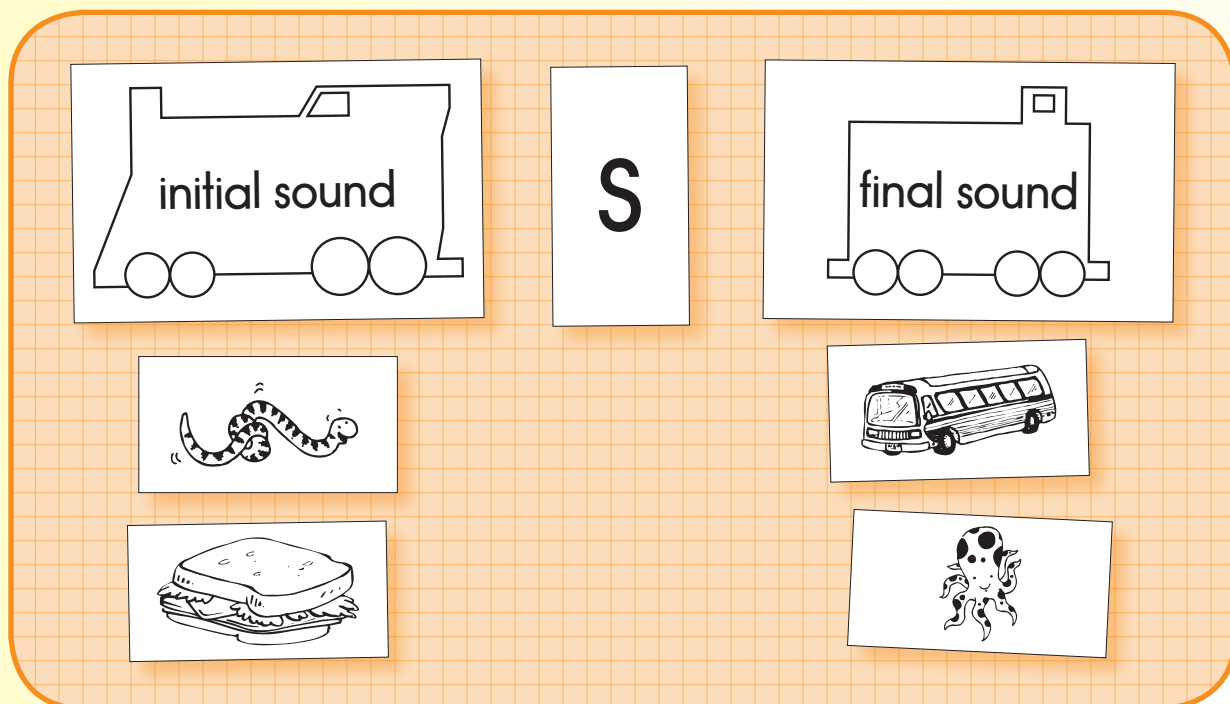

The diagram illustrates the activity setup on a grid background. It features three main components in a row: an 'initial sound' train card (a train with four wheels), a letter card with the letter 'S', and a 'final sound' train card (a train with four wheels). Below these are six picture cards arranged in two columns. The left column contains a snake and a sandwich. The right column contains a bus and an octopus.

Extensions and Adaptations

- ▶ Use other target letters and picture cards.
- ▶ Use digraphs or diphthongs.

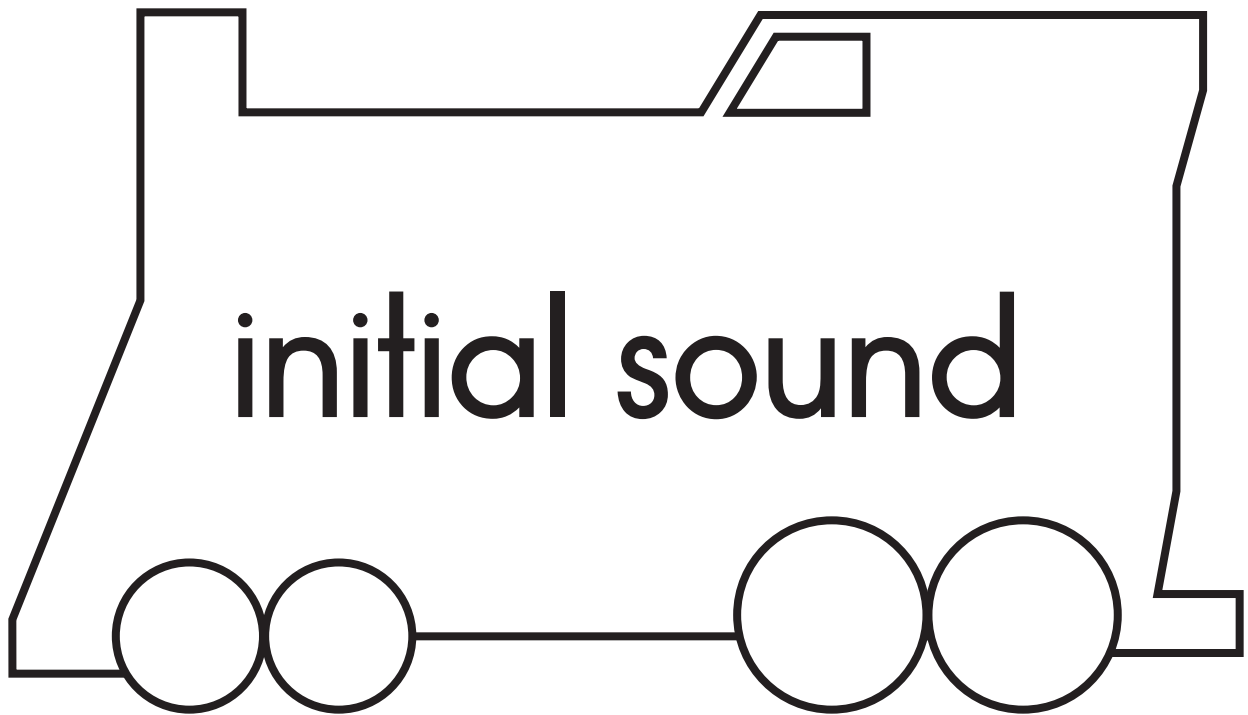

initial and final sound train cards





Letter-Sound Match

Objective

The student will match initial, final, and medial phonemes to graphemes.

Materials

- ▶ Picture cards (Activity Master P.025.AM1)
Note: The pictures used are: ant, map, pin, bib, bug, dog, cry, leg, fly, sun
- ▶ Student sheet (Activity Master P.025.SS1)
- ▶ Scissors
- ▶ Glue

Activity

Students sort pictures by matching phonemes to graphemes and write missing letters.

1. Provide the student with a student sheet and picture card Activity Master. Place scissors and glue at the center.
2. The student cuts out the pictures. Selects a picture, names it, and says each sound (e.g., “bug, /b//u//g/”).
3. Looks for the letters that correspond to two of the sounds.
4. Glues the picture in the fourth column next to the two letters. Looks at the blank space in the row, determines the missing sound, and writes the corresponding letter (i.e., “/b//u//g/, the missing letter is g”).
5. Continues until all blanks are filled.
6. Teacher evaluation

Name _____

Letter-Sound Match P.025.SS1

m		p	picture
	i	n	picture
b	u		
a		t	picture
b	i		picture
s	u		picture
c		y	picture
	e	g	picture
f		y	picture
	o	g	picture

©2005 The Florida Center for Reading Research. All rights reserved. ©2008

Extensions and Adaptations

- ▶ Use other pictures and words (Activity Master P.025.SS2).

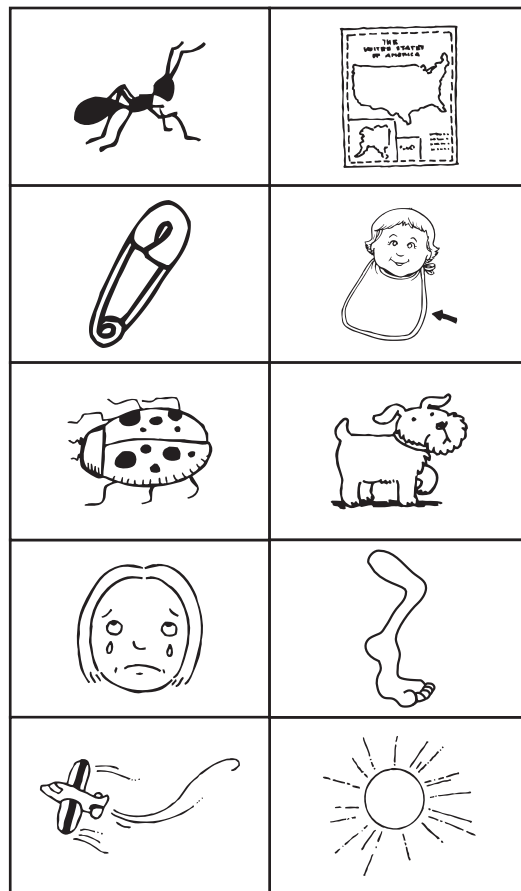

Name _____

Letter-Sound Match

P.025.SS I

m		p	picture
	i	n	picture
b	u		picture
a		t	picture
b	i		picture
s	u		picture
c		y	picture
	e	g	picture
f		y	picture
	o	g	picture

Name _____

P.025.SS2

Picture Letter-Sound Match

			picture
			picture
			picture
			picture
			picture
			picture
			picture
			picture
			picture
			picture
			picture

Phonics

Letter-Sound Correspondence Cards – Initial

P.LSC-I.1

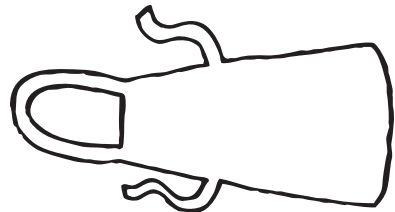
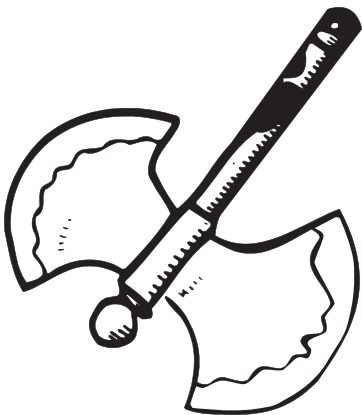
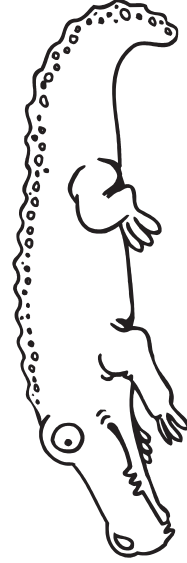
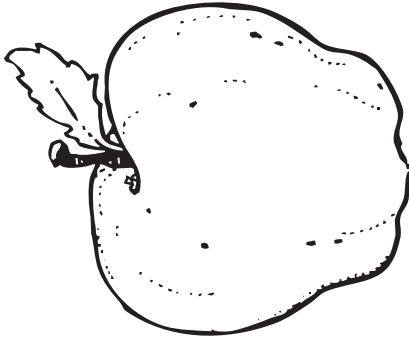
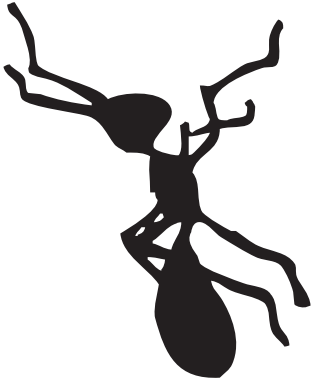

ant, apple, alligator, ax, ape, apron



P.LSC-I.2

Letter-Sound Correspondence Cards – Initial

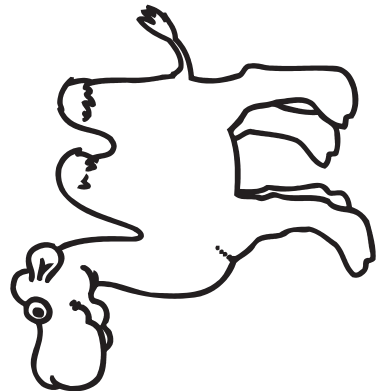
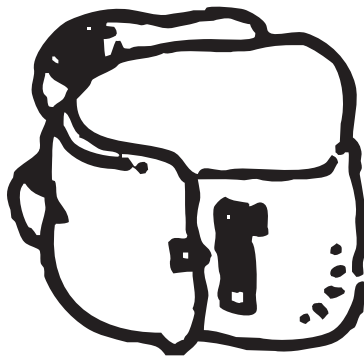
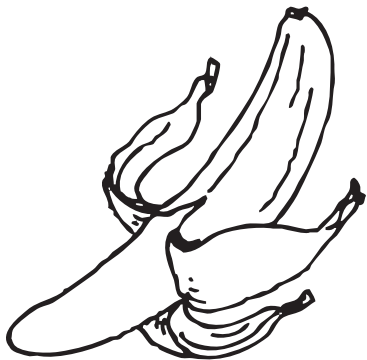
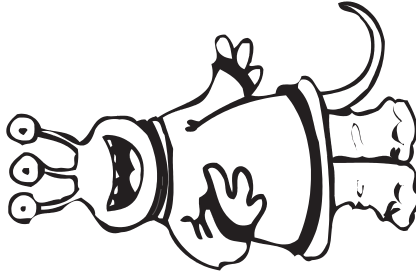
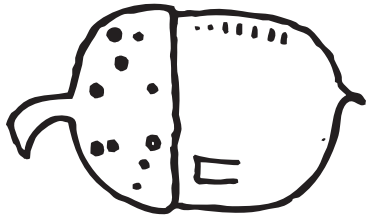

acorn, alien, beach, banana, backpack, camel



Phonics

Letter-Sound Correspondence Cards – Initial

P.LSC-I.3

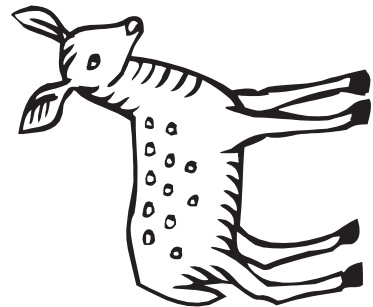
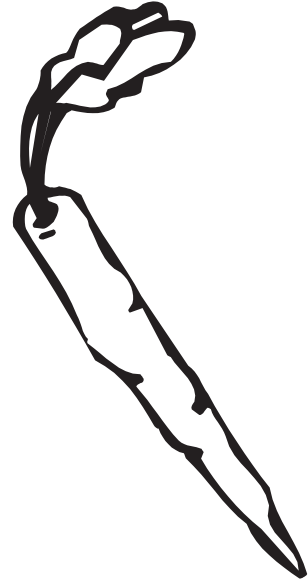
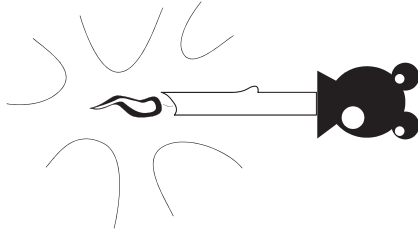

cane, candle, carrot, doughnut, dragon, deer



P.LSC-I.4

Letter-Sound Correspondence Cards – Initial

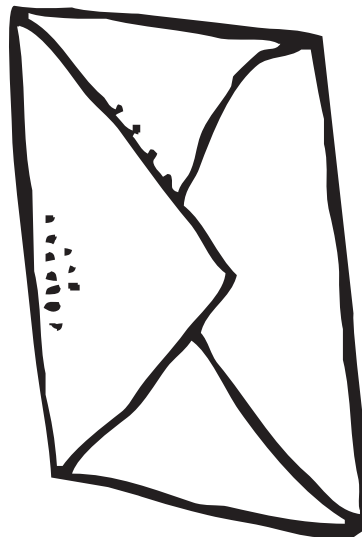
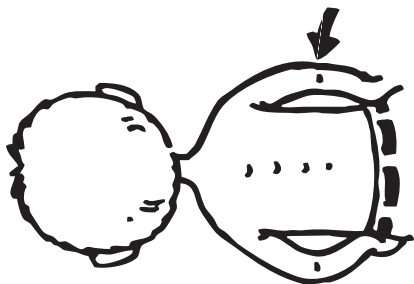
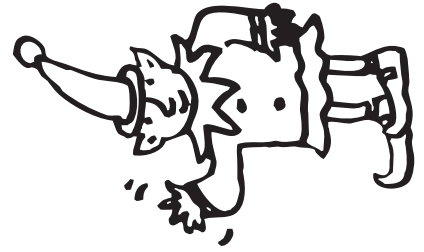
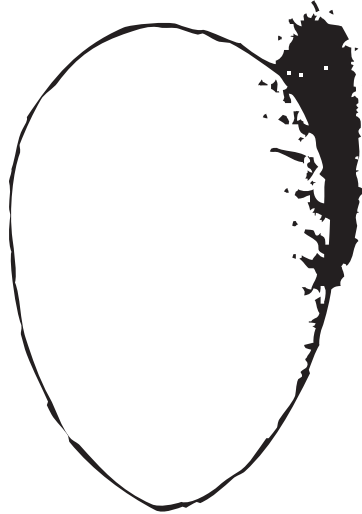
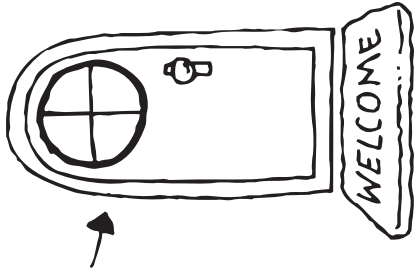

$$2 + 2 = 4$$

door, egg, elf, elbow, envelope, equal



Phonics

Letter-Sound Correspondence Cards – Initial

P.LSC-I.5

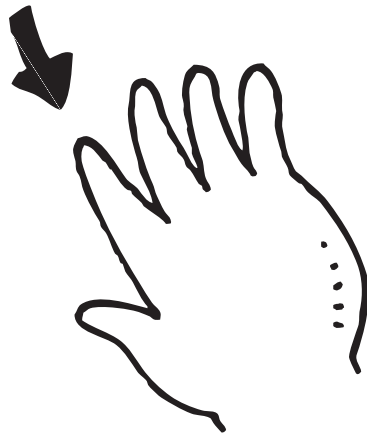
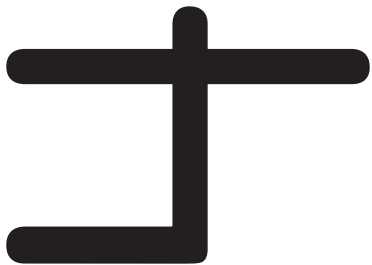
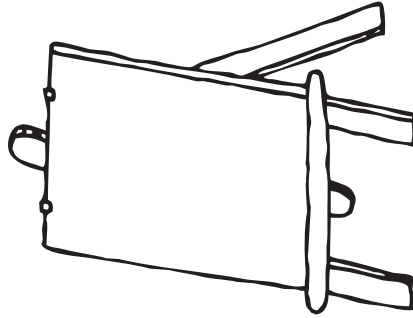

eagle, easel, eat, four, finger, feather



P.LSC-I.6

Letter-Sound Correspondence Cards – Initial

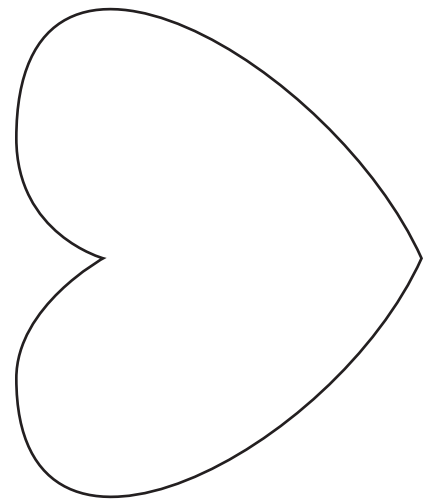
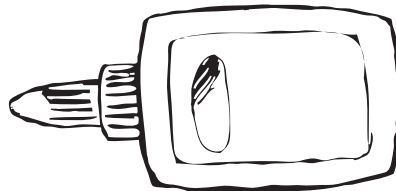
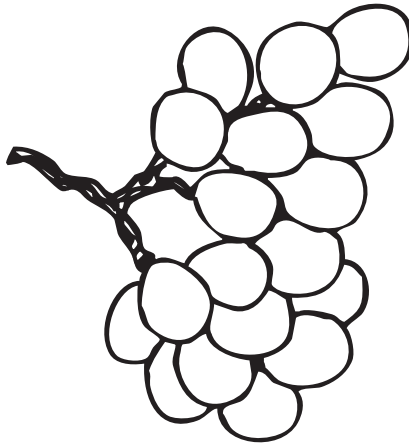
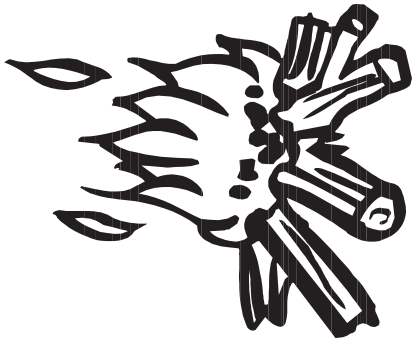

fire, grapes, guitar, gold, glue, heart



Phonics

Letter-Sound Correspondence Cards – Initial

P.LSC-I.7

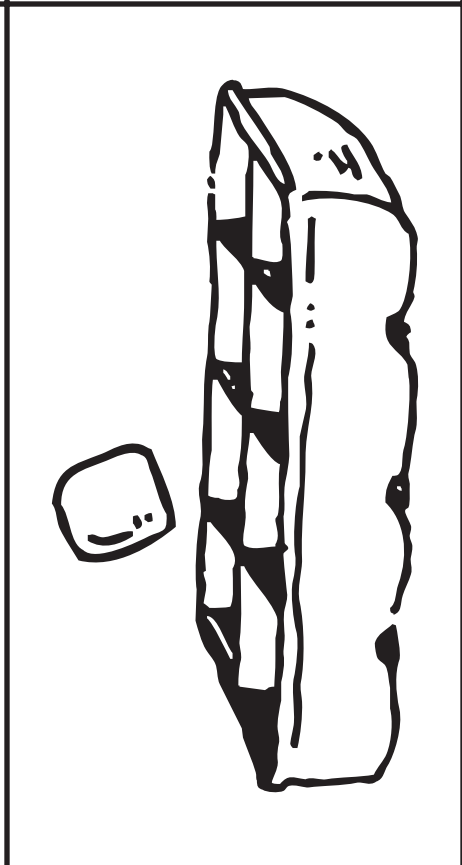
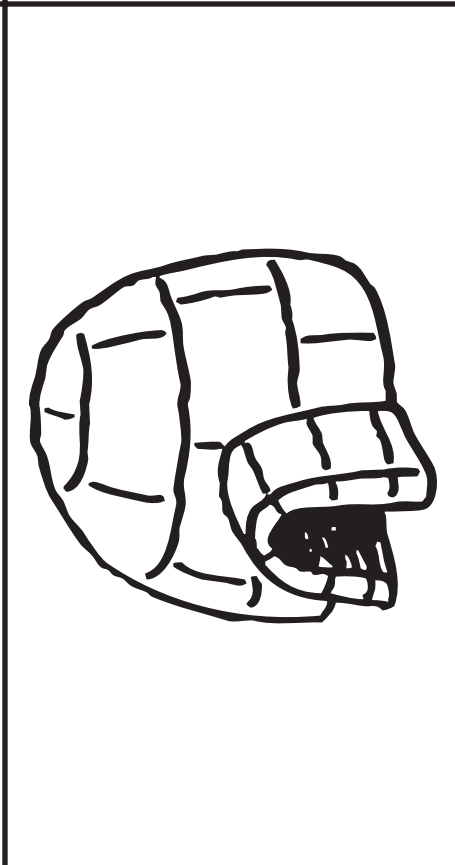
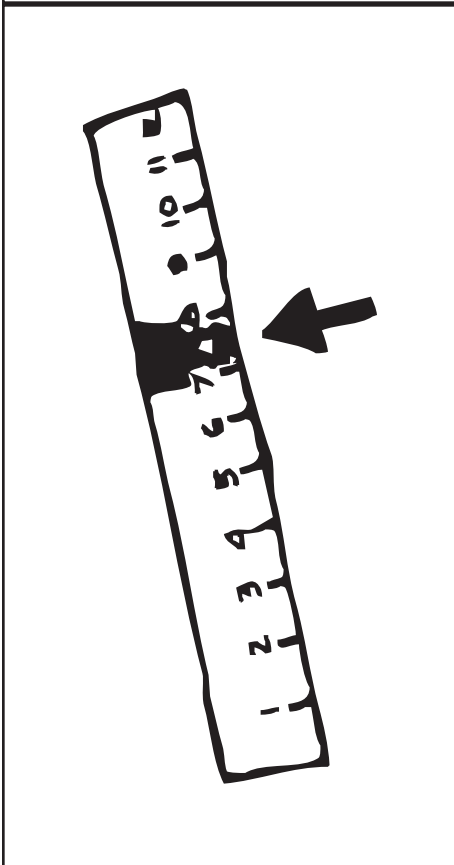
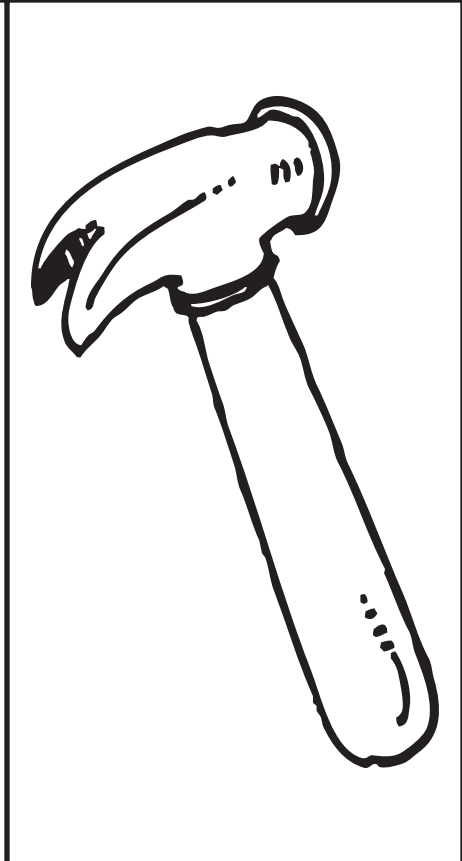
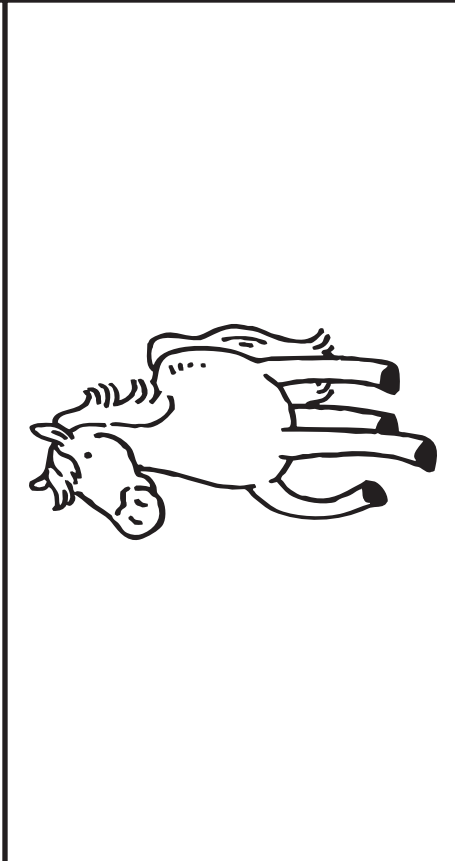

hippopotamus, horse, hammer, inch, igloo, ice



P.LSC-I.8

Letter-Sound Correspondence Cards – Initial

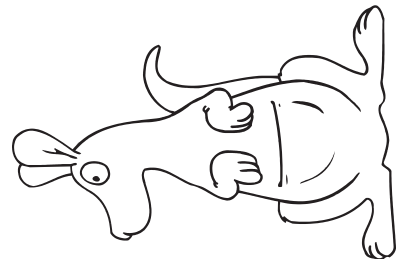
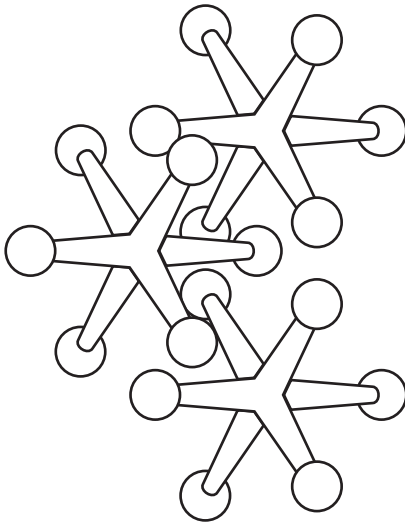
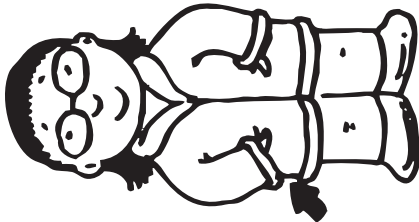
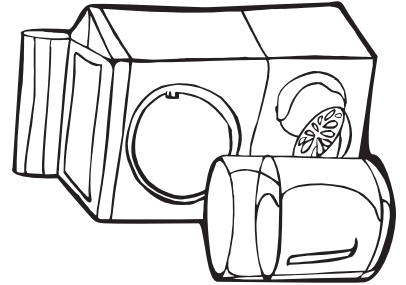
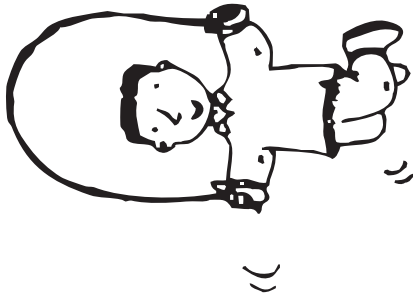
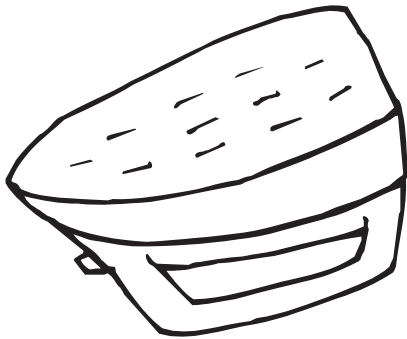

iron, jump, juice, jacket, jacks, kangaroo



Phonics

Letter-Sound Correspondence Cards – Initial

P.LSC-I.9

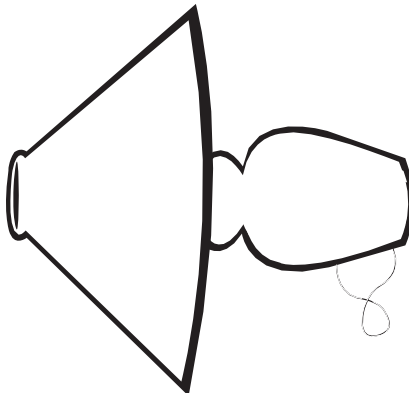
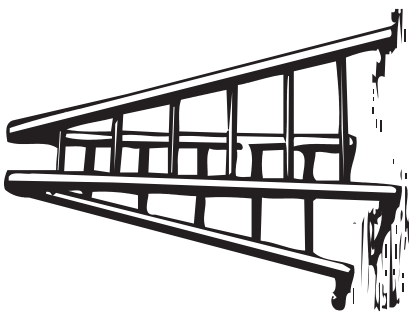
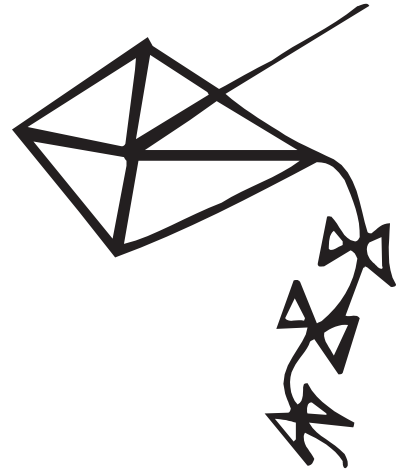
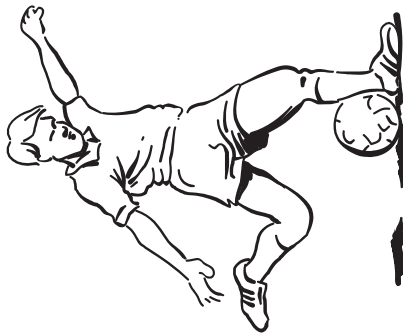

key, kick, kite, ladder, lamp, lion



P.LSC-I.10

Letter-Sound Correspondence Cards – Initial

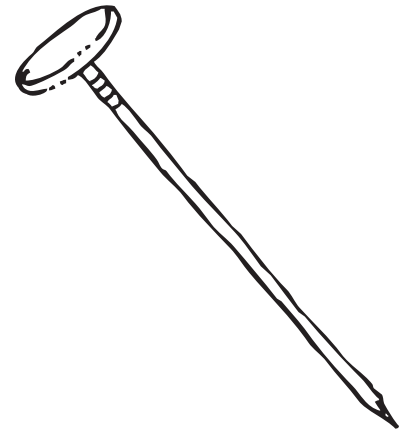
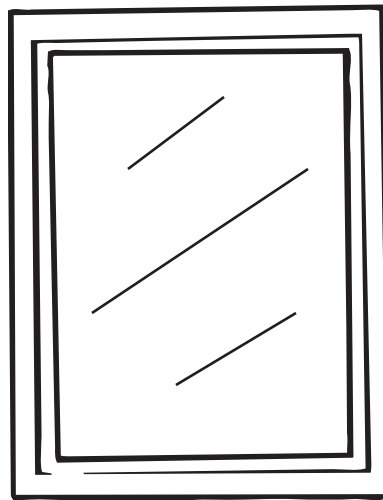
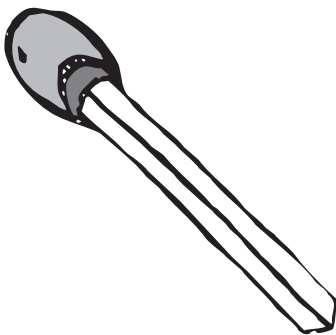
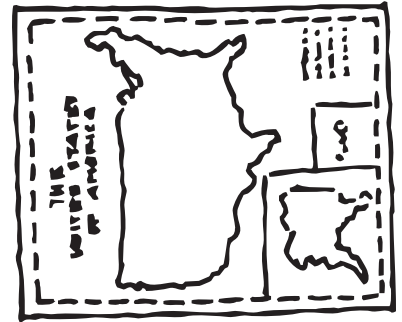
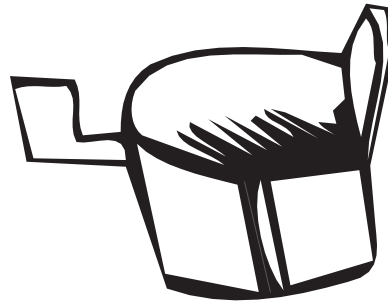
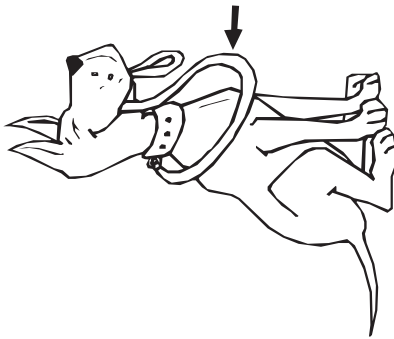

leash, mailbox, map, match, mirror, nail



Phonics

Letter-Sound Correspondence Cards – Initial

P.LSC-I.1.1

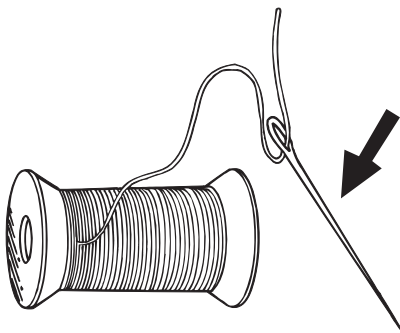
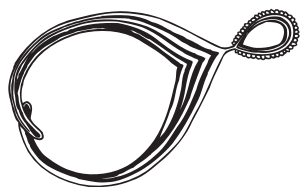

necklace, needle, nurse, octopus, ox, olive



P.LSC-I.12

Letter-Sound Correspondence Cards – Initial

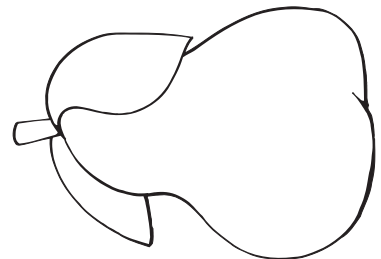
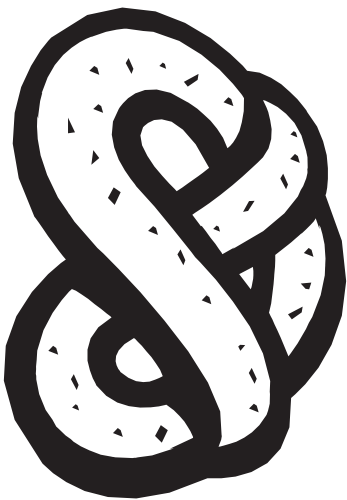
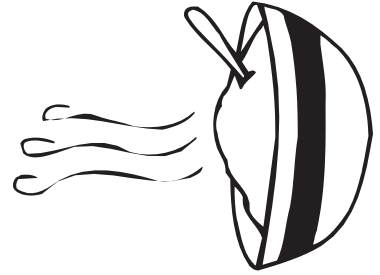
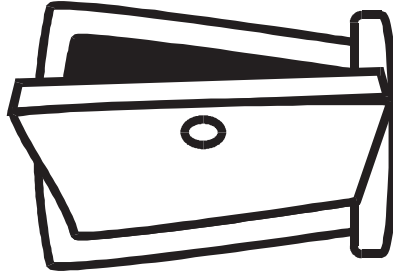

ostrich, open, oatmeal, pretzel, pillow, pear



Phonics

Letter-Sound Correspondence Cards – Initial

P.LSC-I.13

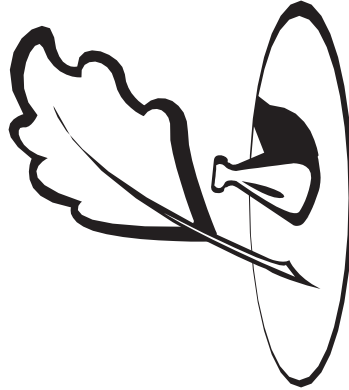
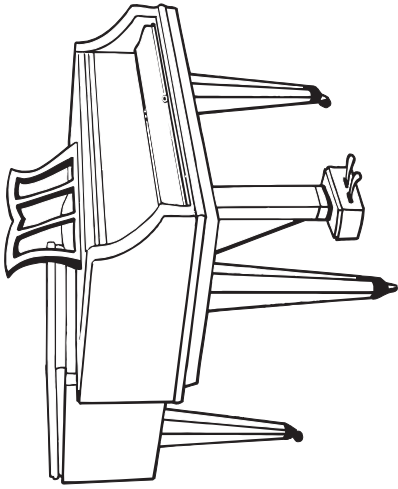

piano, quill, queen, question, quarter, rabbit



P.LSC-I.14

Letter-Sound Correspondence Cards – Initial

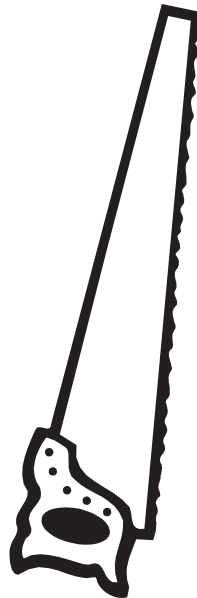
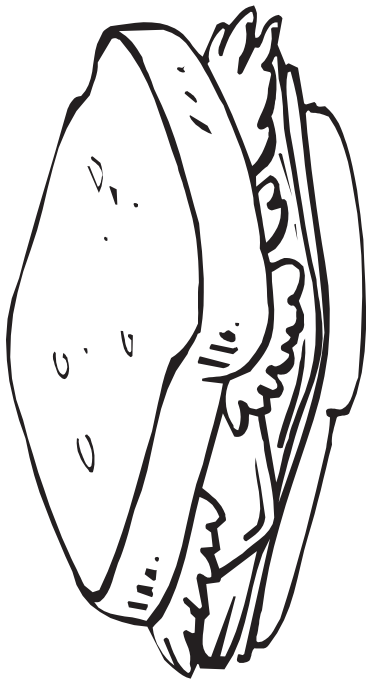
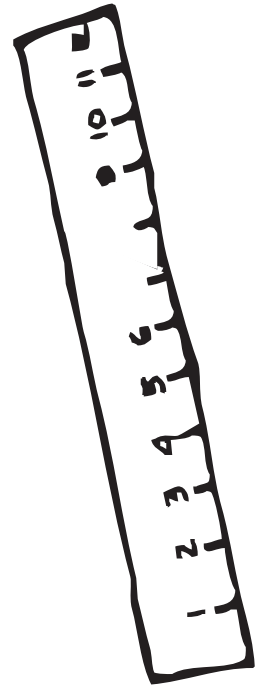
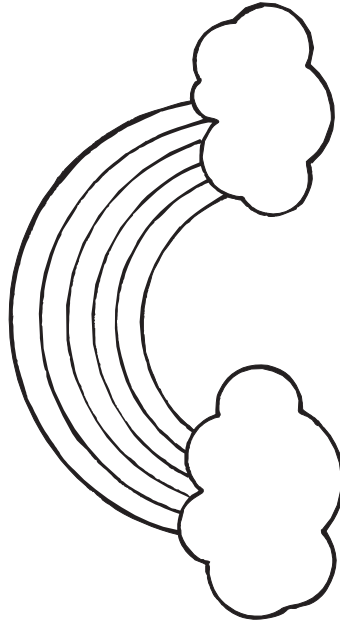
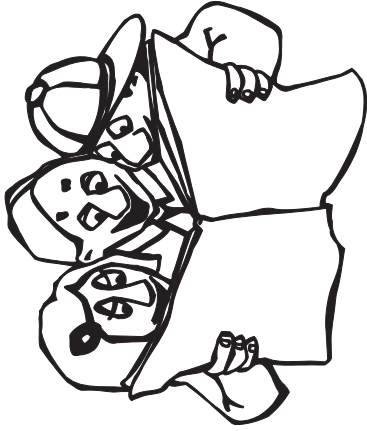

read, rainbow, ruler, sandwich, saw, seven



Phonics

Letter-Sound Correspondence Cards – Initial

P.LSC-I.15

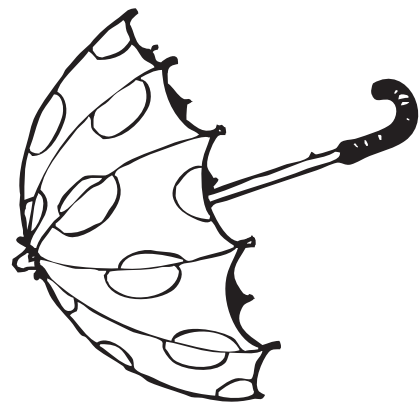
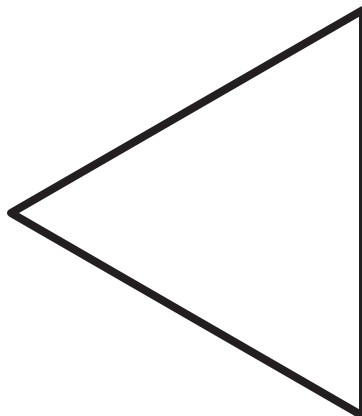
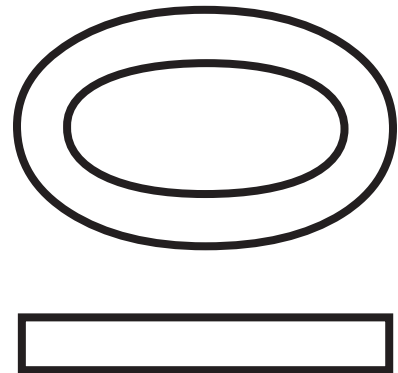
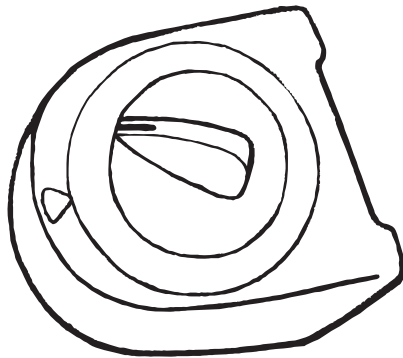

snake, timer, ten, tire, triangle, umbrella



P.LSC-I.16

Letter-Sound Correspondence Cards – Initial

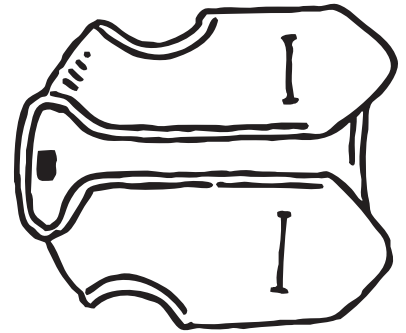
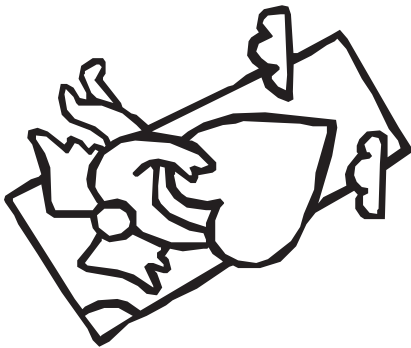
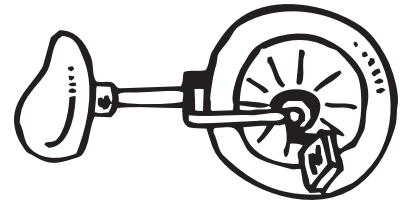
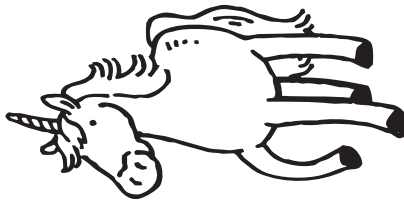

umpire, unicorn, unicycle, valentine, vacuum, vest



Phonics

Letter-Sound Correspondence Cards – Initial

P.LSC-I.17

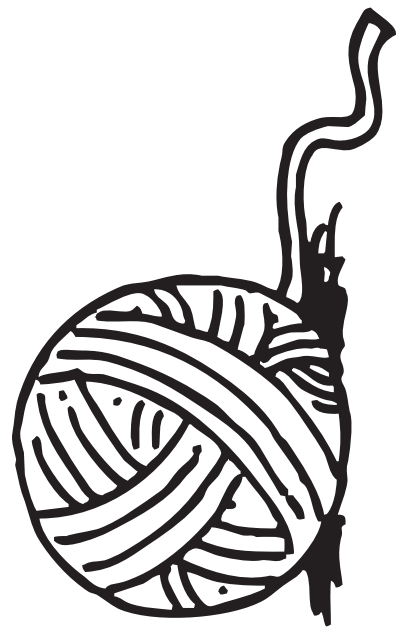
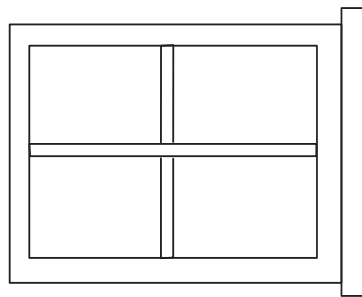
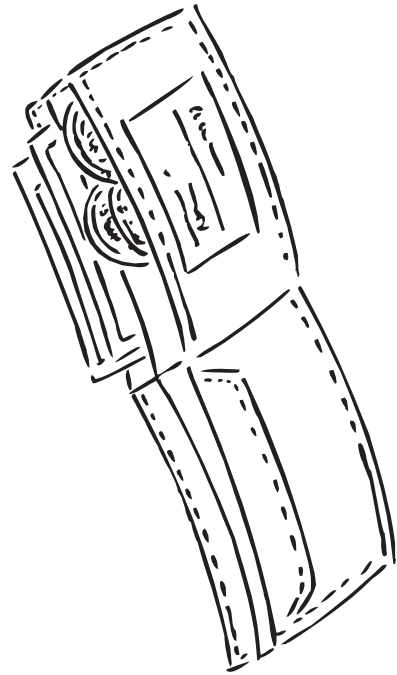
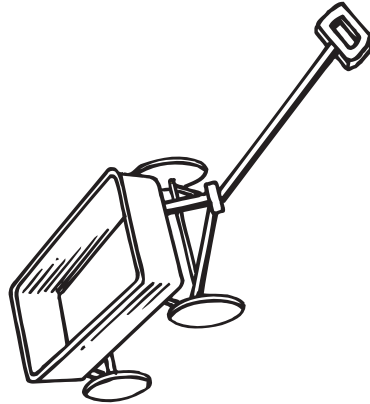
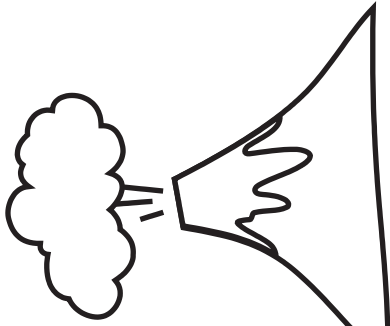

volcano, wagon, wallet, watch, window, yarn



P.LSC-I.18

Letter-Sound Correspondence Cards – Initial

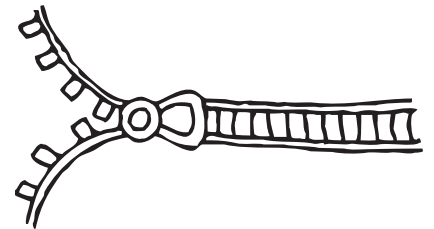
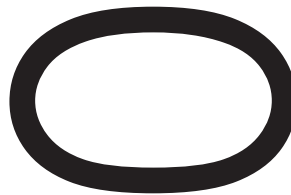
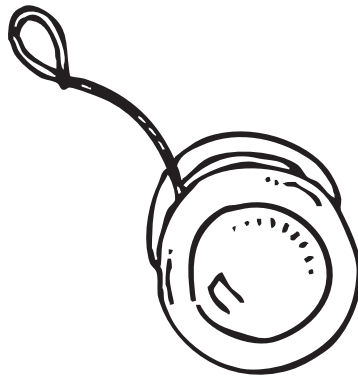
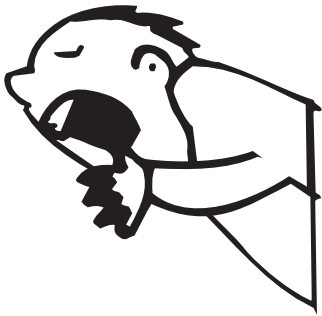

yawn, yo-yo, yak, zebra, zero, zipper



Phonics

Letter-Sound Correspondence Cards – Initial

P.LSC-I.19

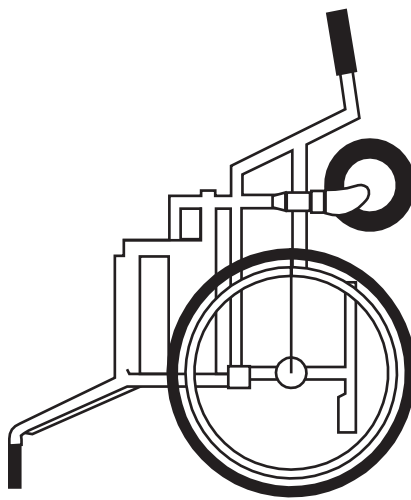
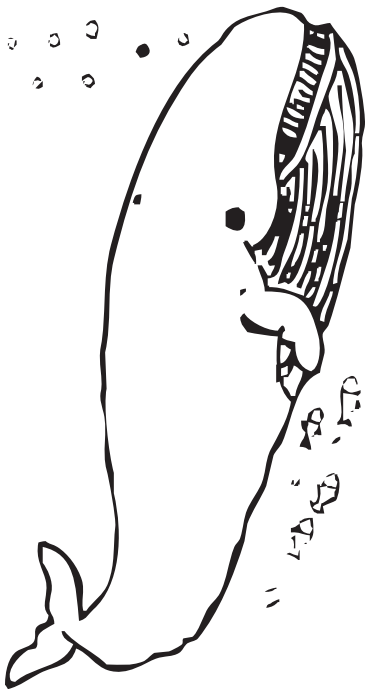
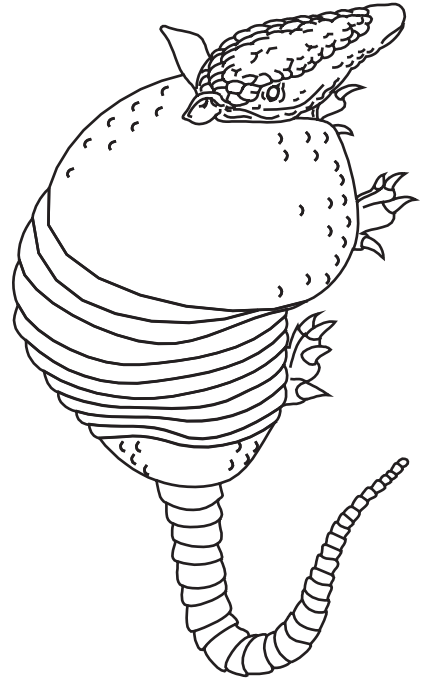
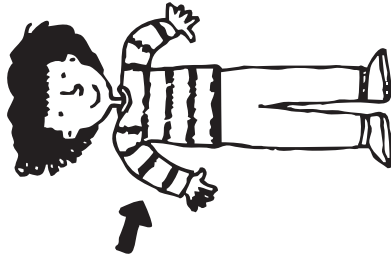

zoo, arm, armadillo, whale, wheelchair, whistle



P.LSC-I.20

Letter-Sound Correspondence Cards – Initial

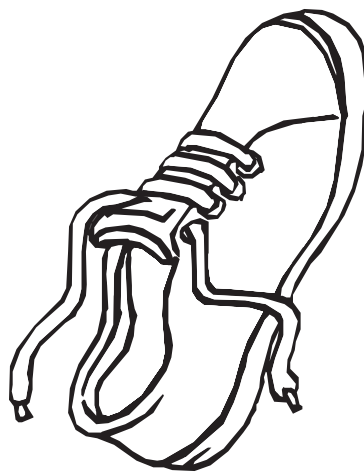
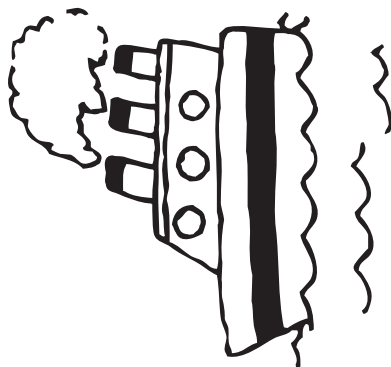
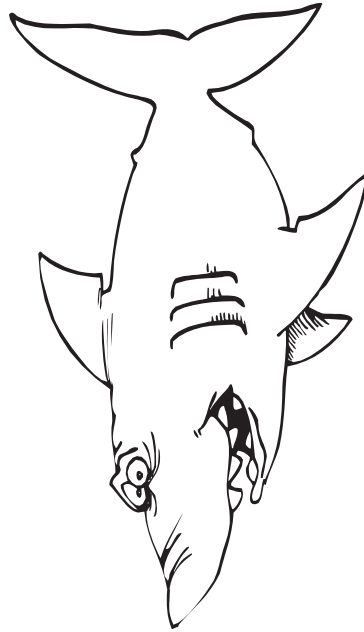
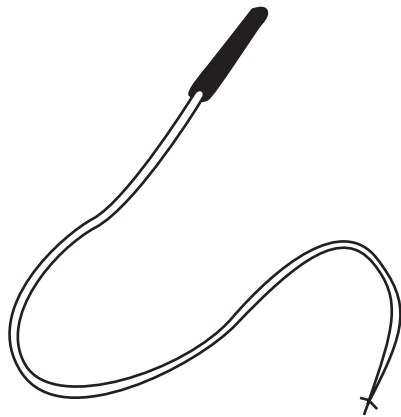

whip, shark, shell, ship, shoe, thermometer



Phonics

Letter-Sound Correspondence Cards – Initial

P.LSC-I.2I

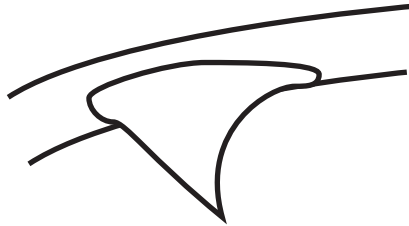
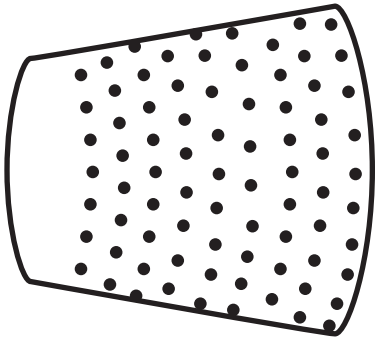

30

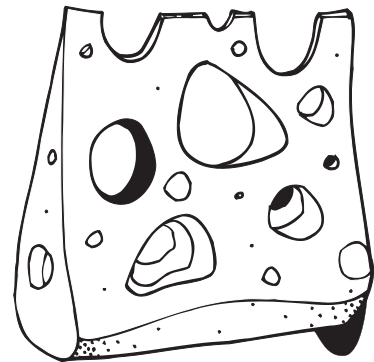
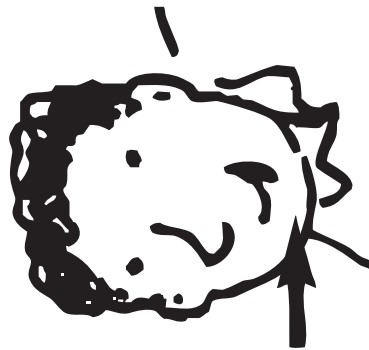
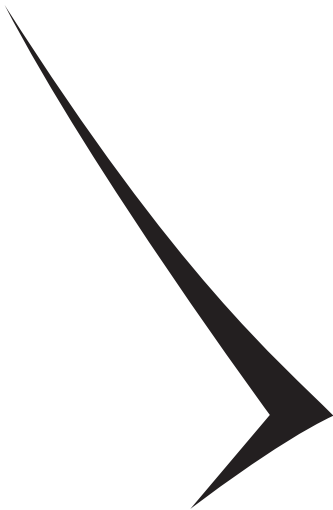

thimble, thorn, thirty, check, chin, cheese



P.LSC-I.22

Letter-Sound Correspondence Cards – Initial

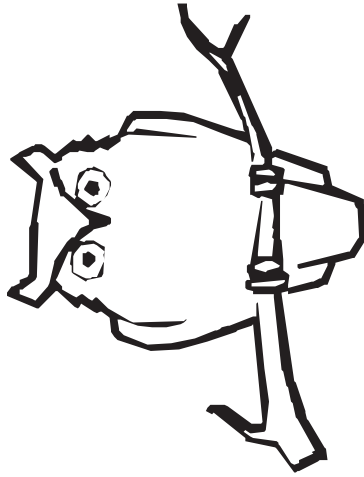
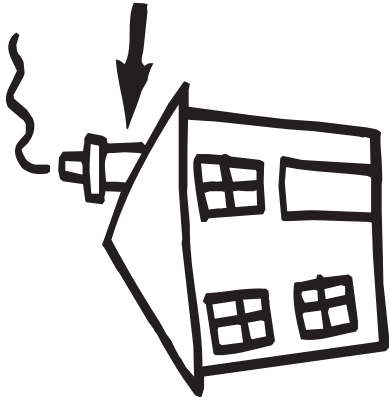

chimney, owl, ouch



Phonics

Letter-Sound Correspondence Cards – Medial

P.LSC-M.1

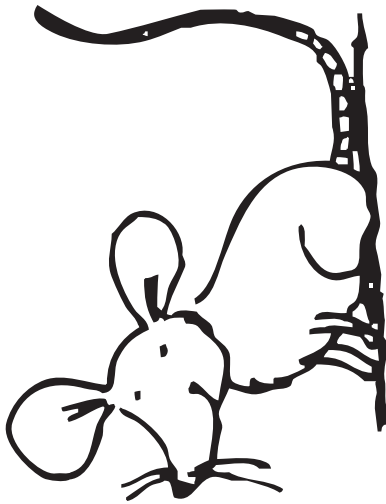
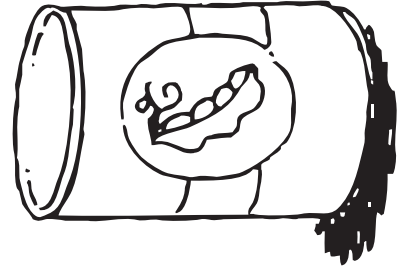
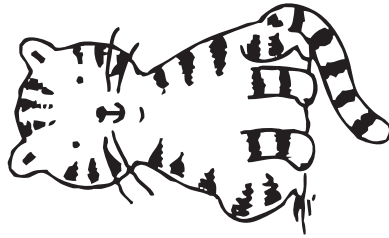
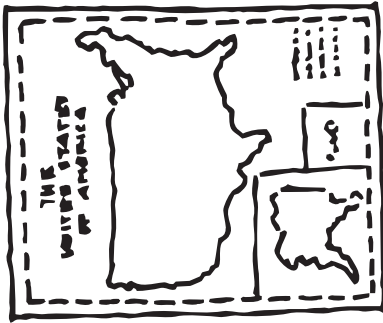

map, cat, can, rat, rain, gate



P.LSC-M.2

Letter-Sound Correspondence Cards – Medial

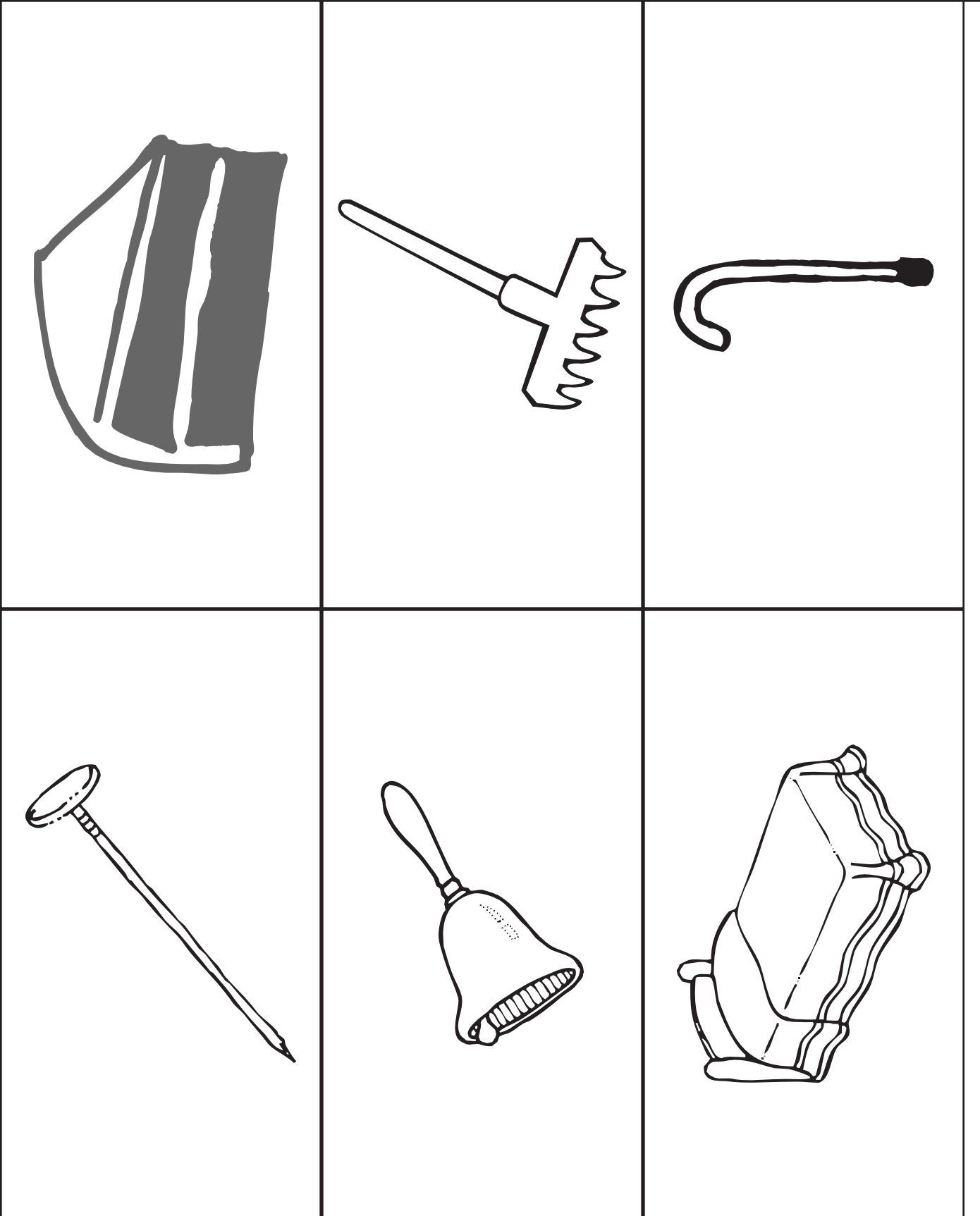

cake, rake, cane, nail, bell, bed



Phonics

Letter-Sound Correspondence Cards – Medial

P.LSC-M.3

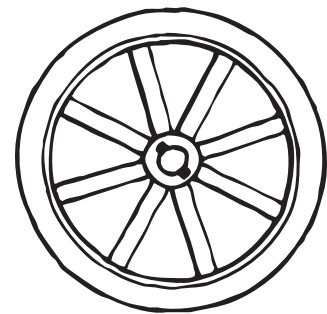
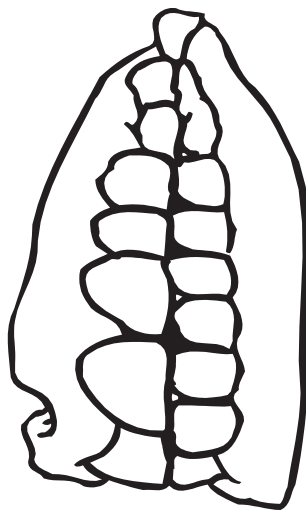
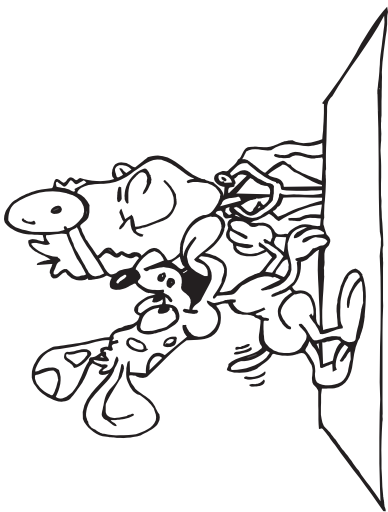
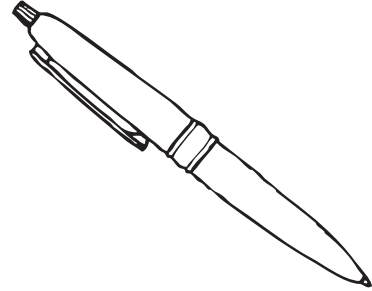
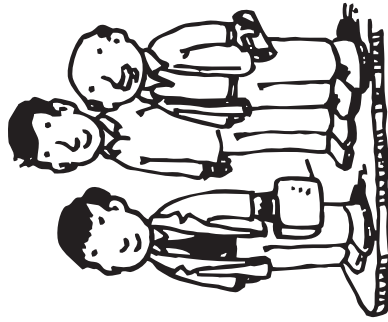
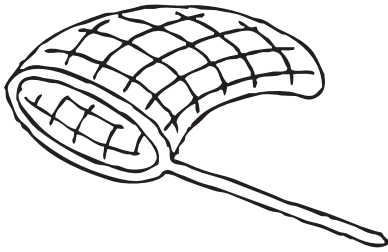

net, men, pen, vet, teeth, wheel



P.LSC-M.4

Letter-Sound Correspondence Cards – Medial

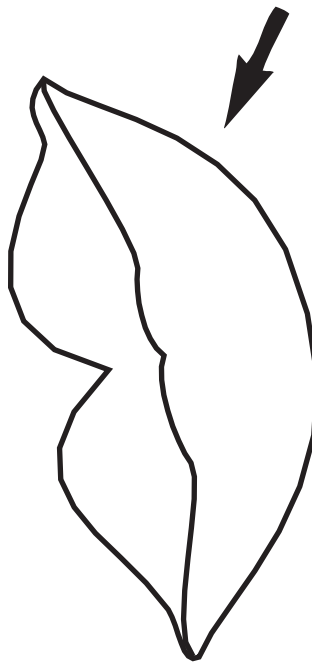
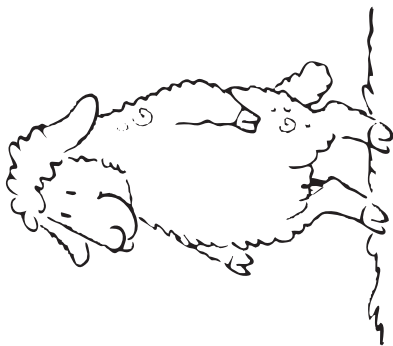
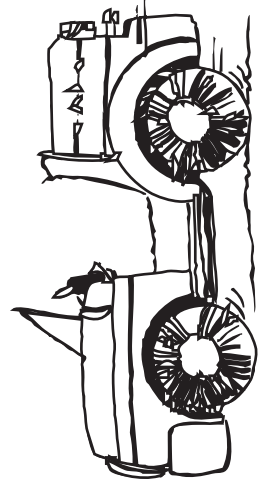
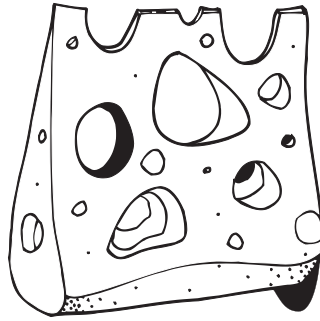
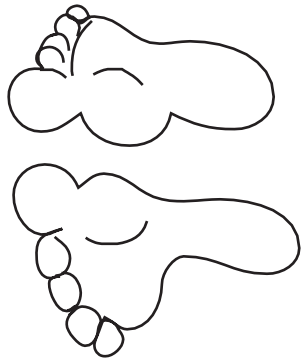

feet, cheese, jeep, sheep, lip, dish



Phonics

Letter-Sound Correspondence Cards – Medial

P.LSC-M.5

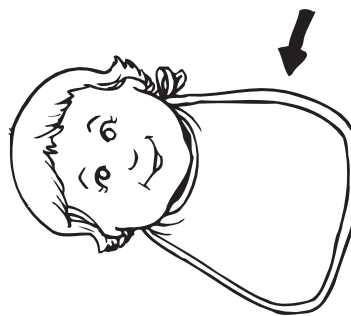
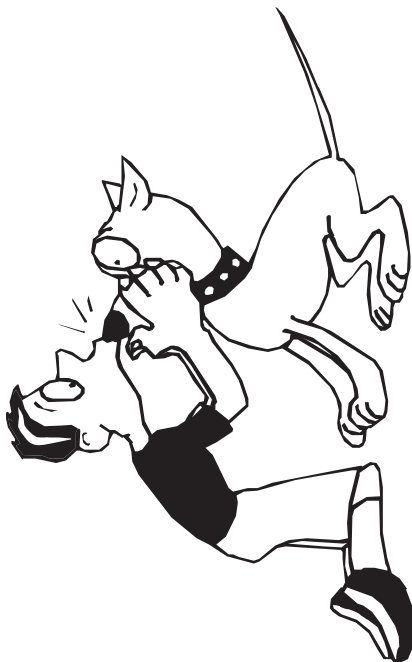
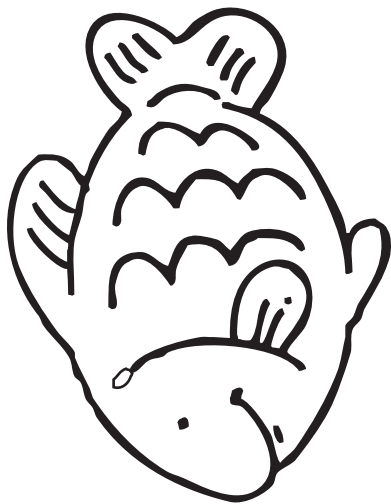

9

5

fish, kiss, bib, pig, nine, five



P.LSC-M.6

Letter-Sound Correspondence Cards – Medial

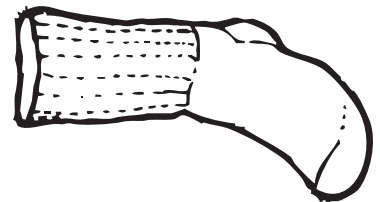
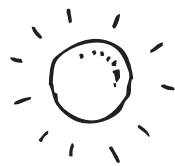
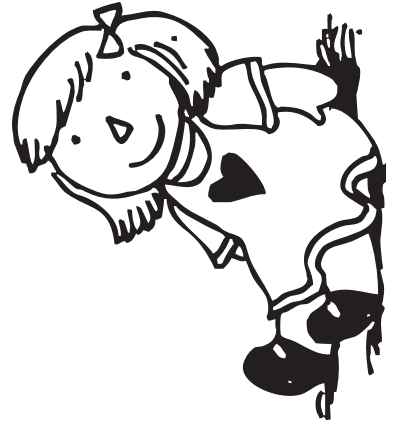
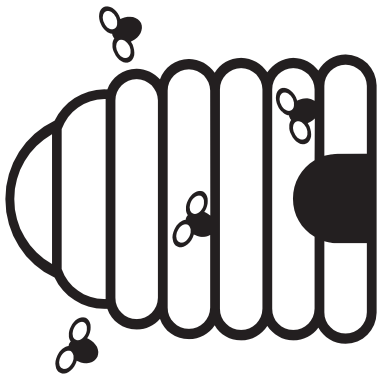

hive, mice, doll, dog, hot, sock



Phonics

Letter-Sound Correspondence Cards – Medial

P.LSC-M.7

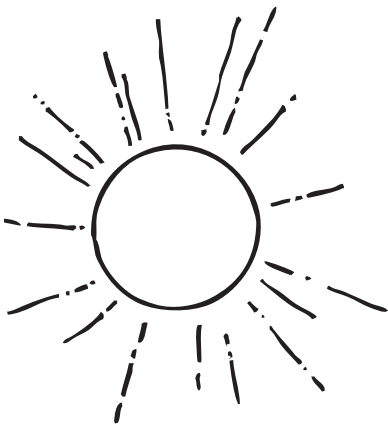
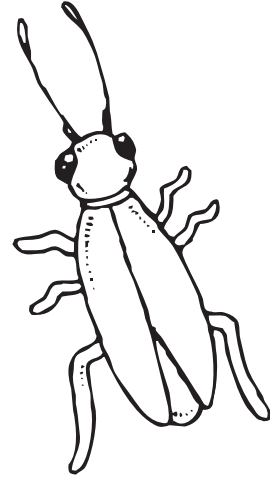
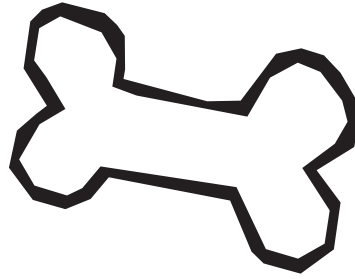
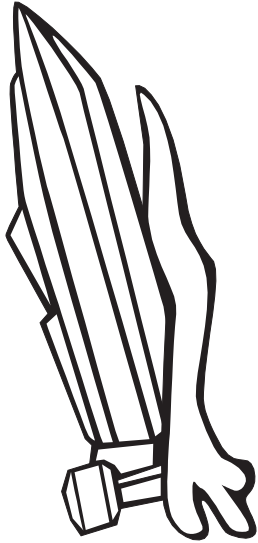

boat, bone, roach, sun, duck, rug



P.LSC-M.8

Letter-Sound Correspondence Cards – Medial

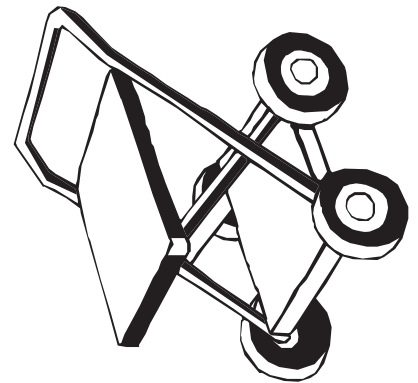
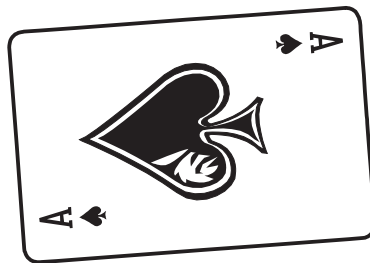
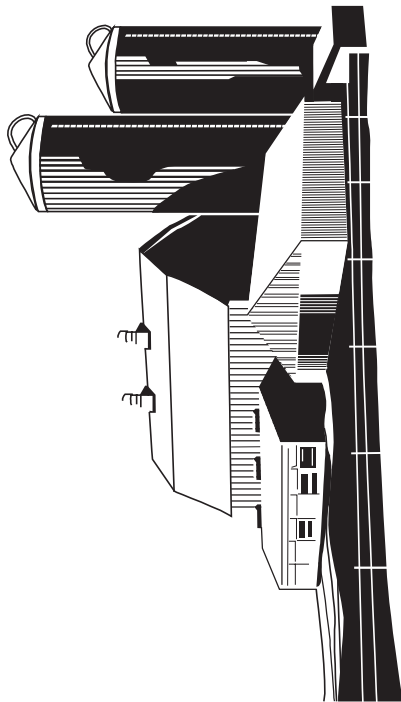
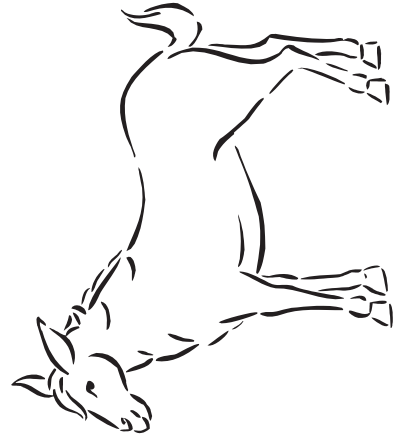
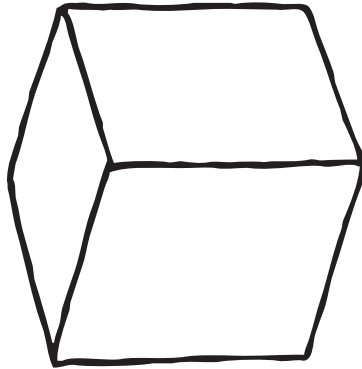
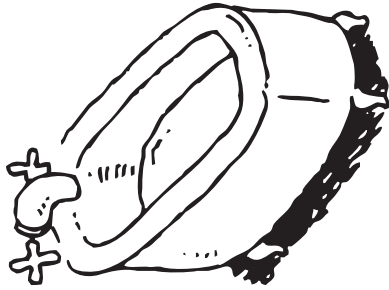

tub, cube, mule, farm, card, cart



Phonics

Letter-Sound Correspondence Cards – Medial

P.LSC-M.9

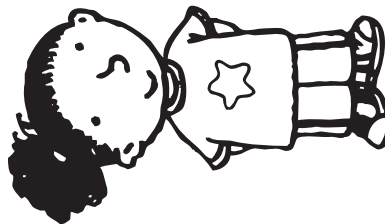
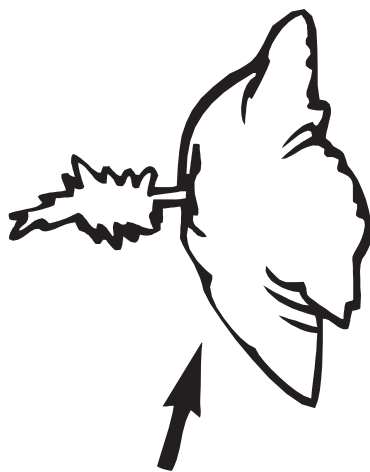
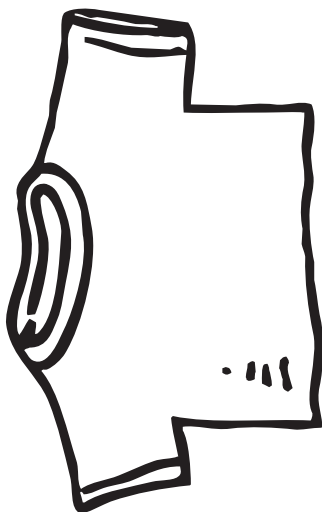
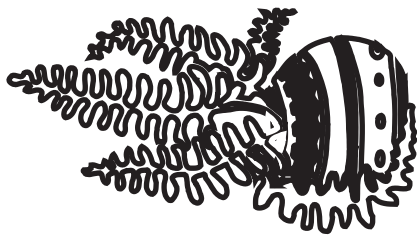
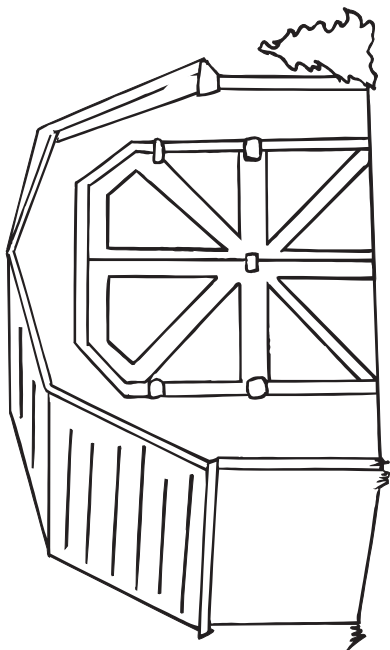

barn, fern, bird, shirt, dirt, girl



P.LSC-M.10

Letter-Sound Correspondence Cards – Medial

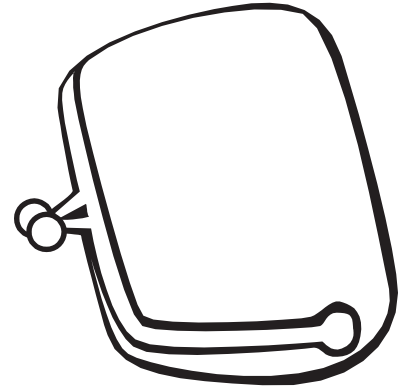
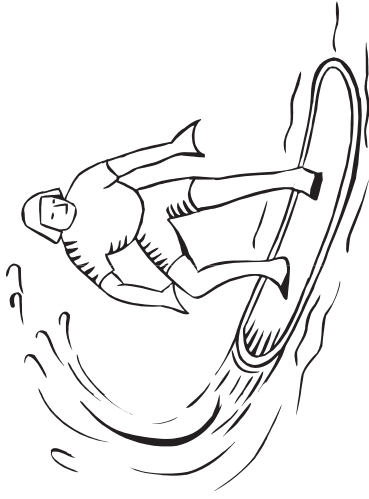

3rd

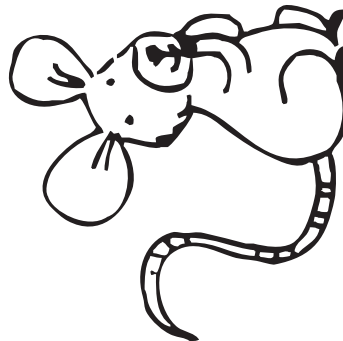

surf, nurse, purse, third, mouse, shower



Phonics

Letter-Sound Correspondence Cards – Medial

P.LSC-M.1.1

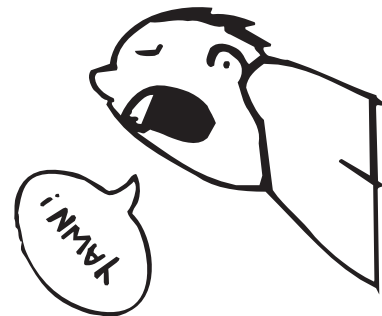
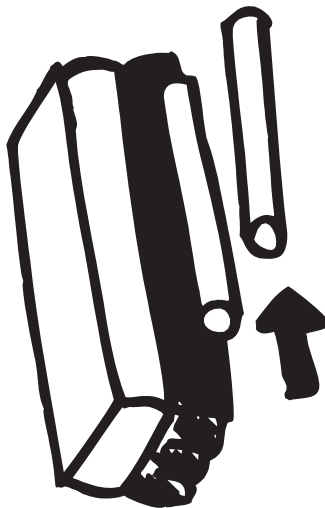
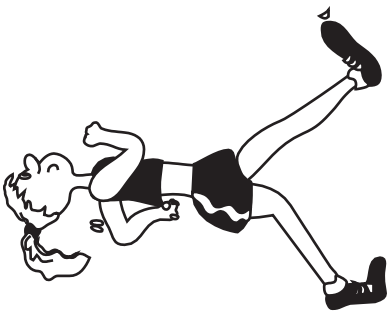
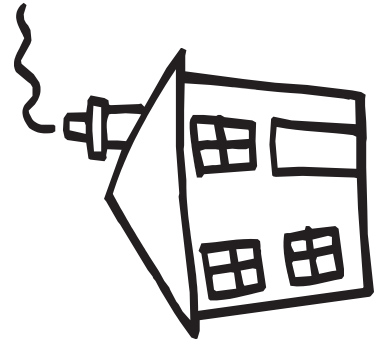
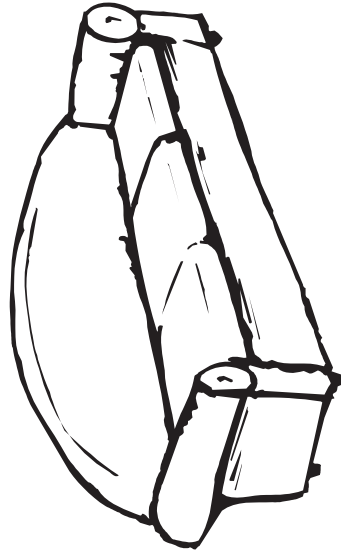
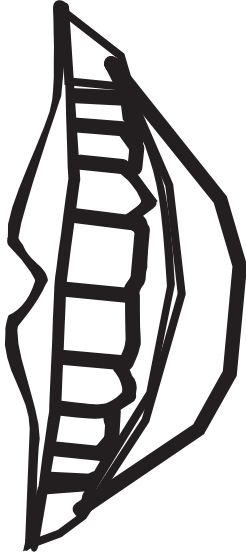

mouth, couch, house, walk, chalk, yawn



P.LSC-M.12

Letter-Sound Correspondence Cards – Medial

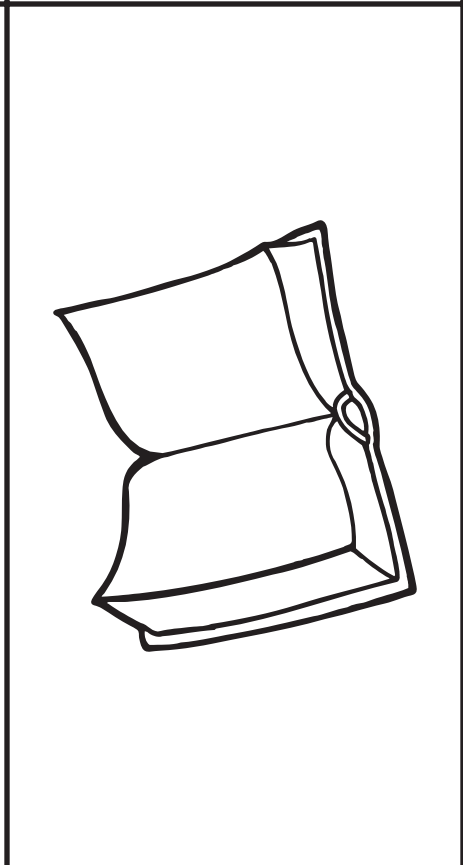
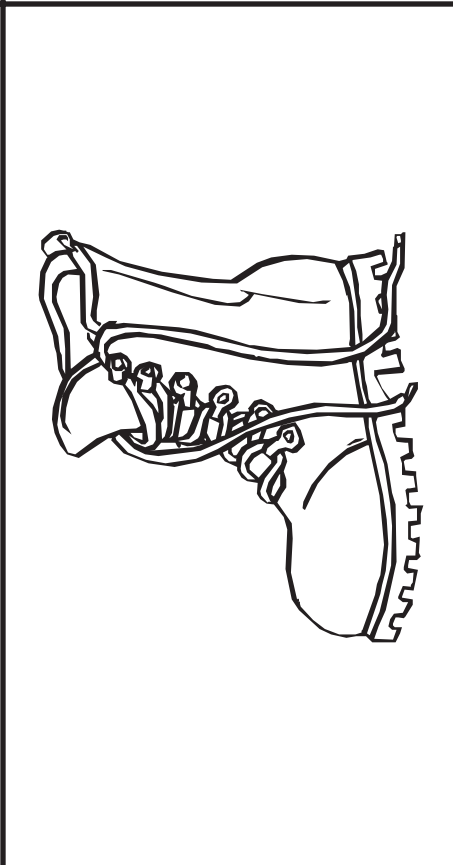
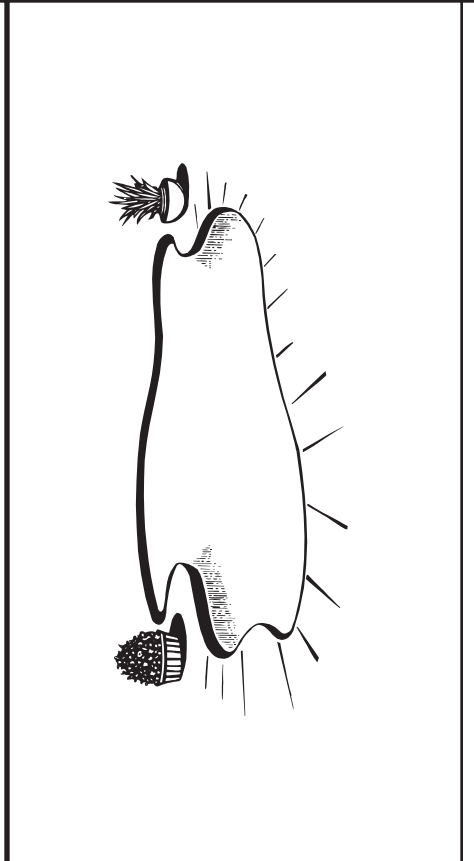
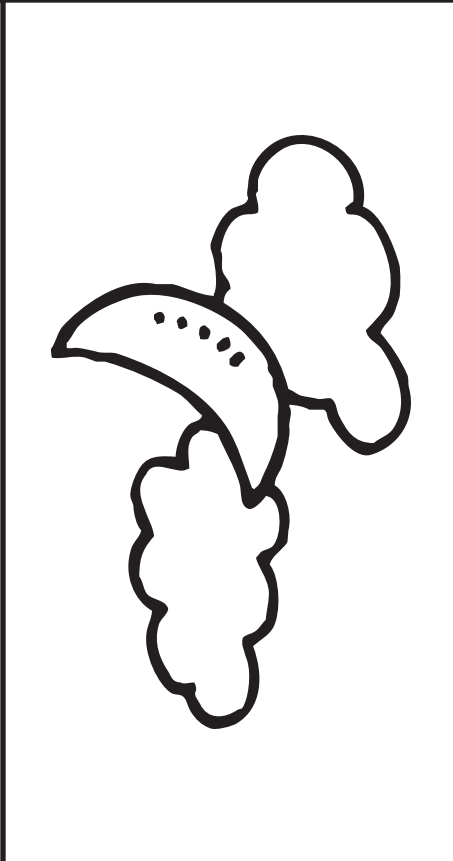
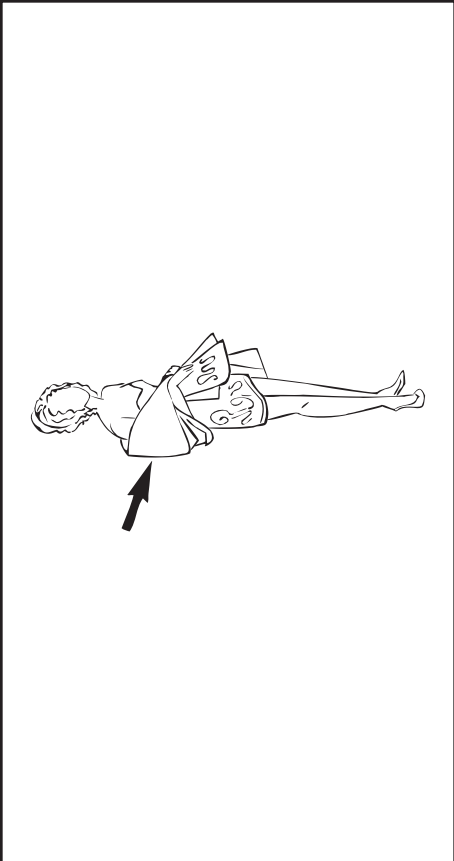

shawl, moon, pool, moose, boot, book



Phonics

Letter-Sound Correspondence Cards – Medial

P.LSC-M.13

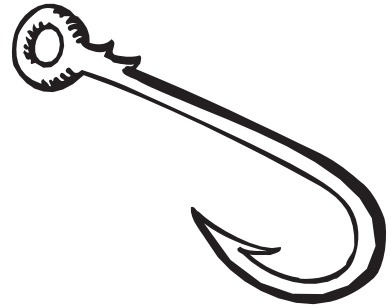
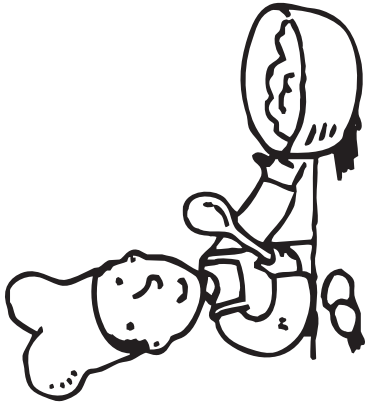

cook, foot, hook, coin, boil



P.LSC-F.1

Letter-Sound Correspondence Cards – Final

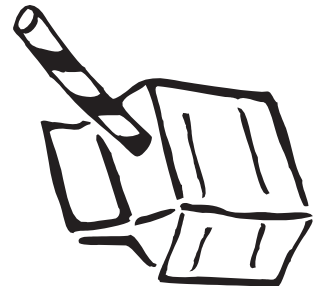
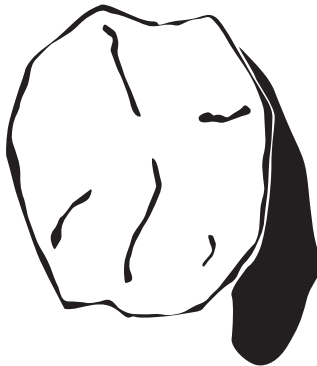
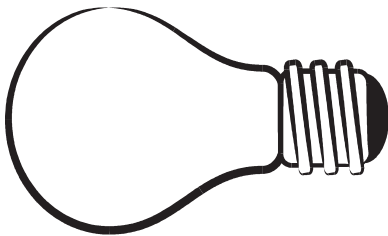
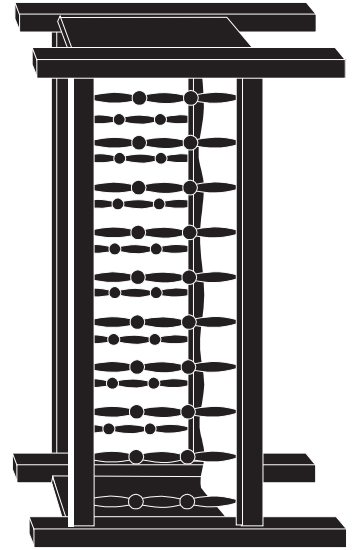
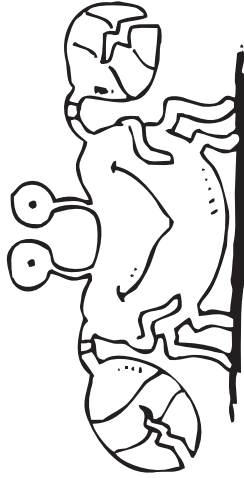
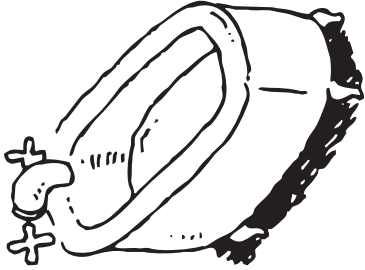

tub, crab, crib, bulb, rock, milk



Phonics

Letter-Sound Correspondence Cards – Final

P.LSC-F.2

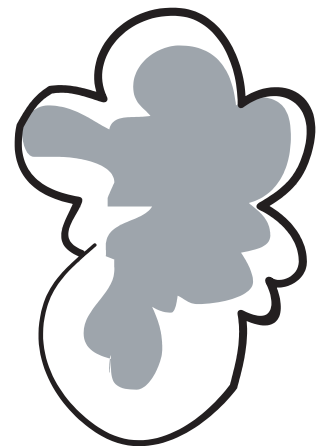
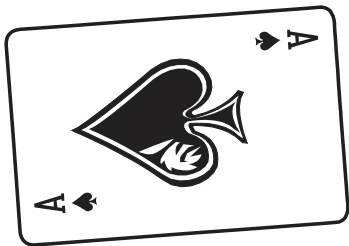
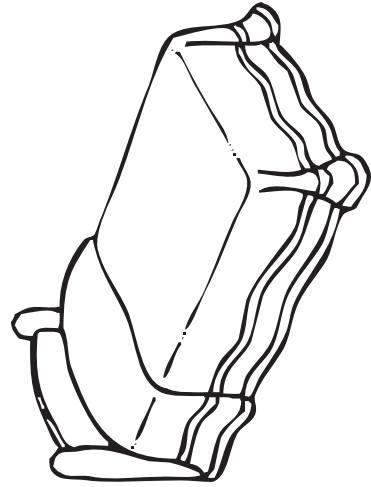
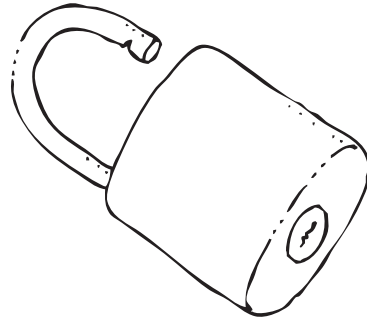
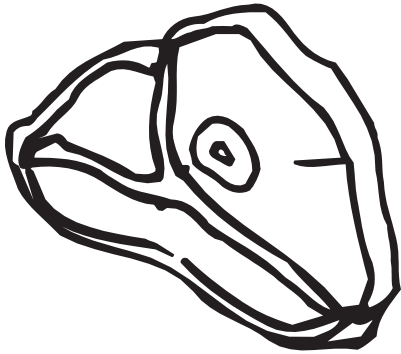

steak, lock, bed, card, bird, cloud



P.LSC-F.3

Letter-Sound Correspondence Cards – Final

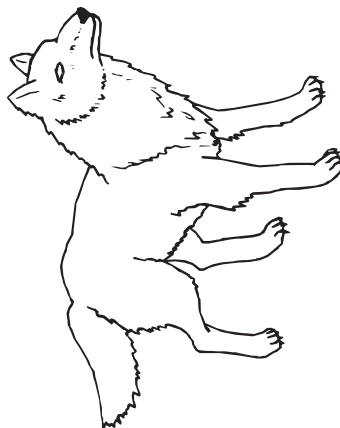

cookie, pea, tea, penny, wolf, elf



Phonics

Letter-Sound Correspondence Cards – Final

P.LSC-F.4

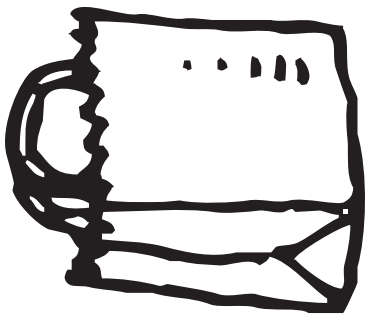
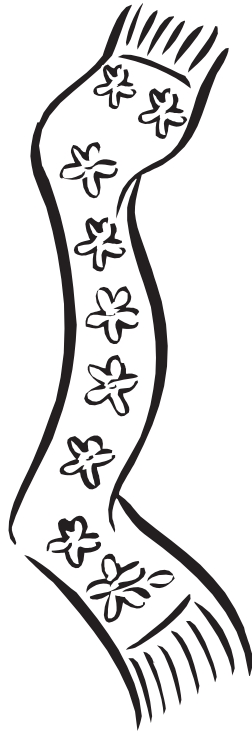
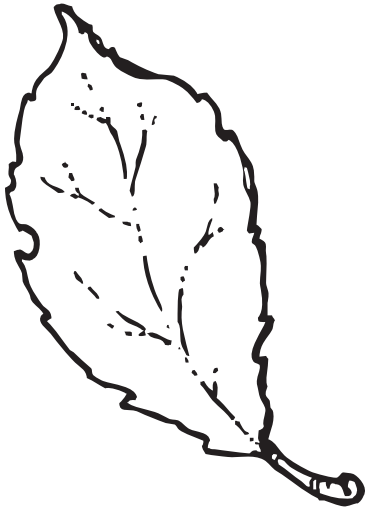

leaf, scarf, bug, bag, frog, log



P.LSC-F.5

Letter-Sound Correspondence Cards – Final

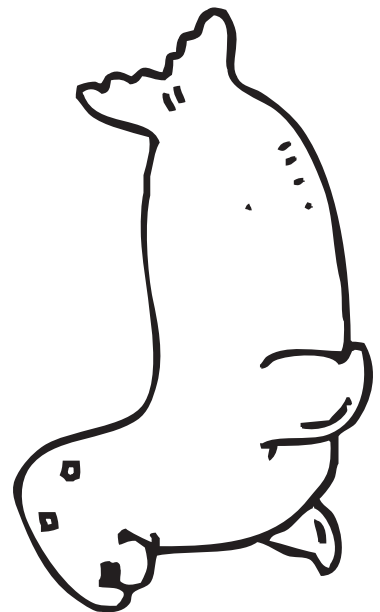
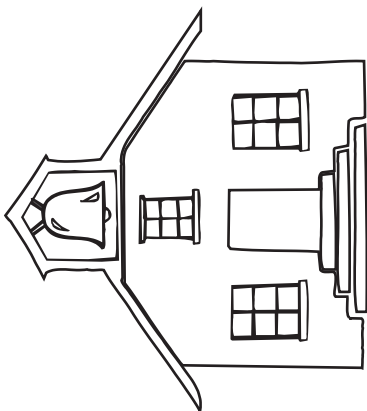
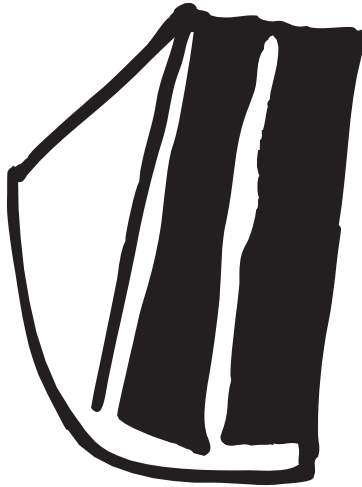
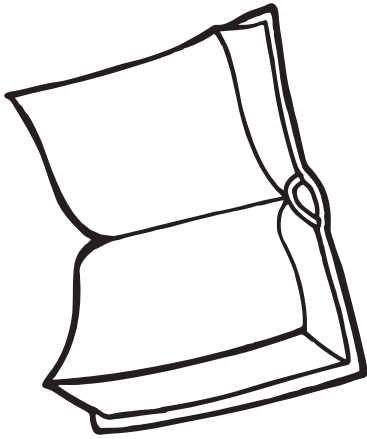

book, cake, stick, school, shovel, seal



Phonics

Letter-Sound Correspondence Cards – Final

P.LSC-F.6

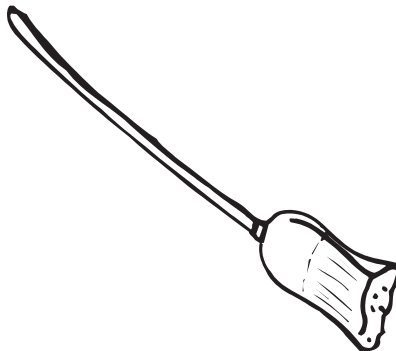
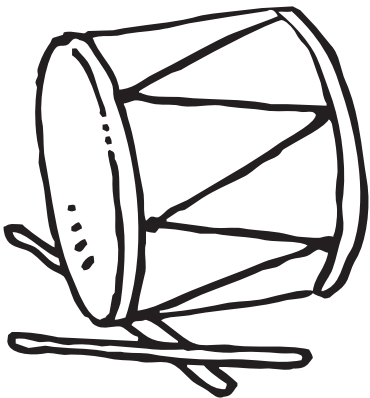
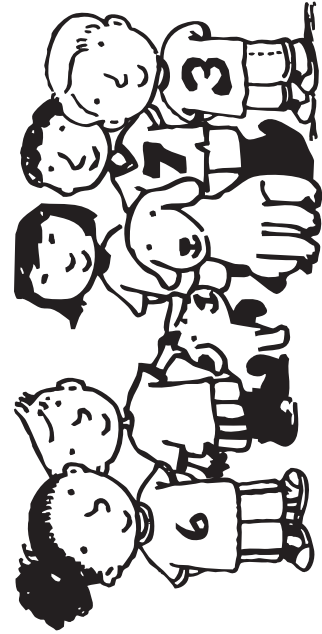
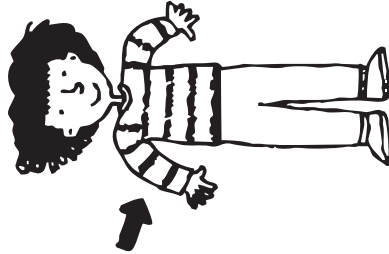
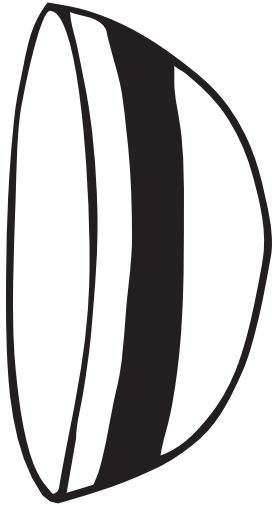

7

bowl, arm, team, drum, broom, seven



P.LSC-F.7

Letter-Sound Correspondence Cards – Final

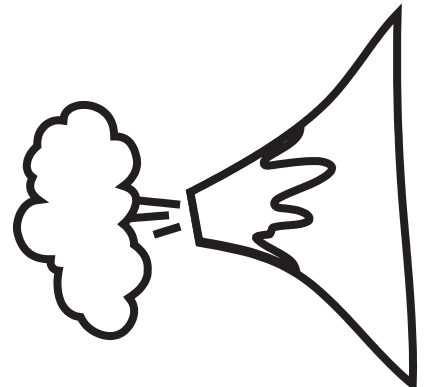
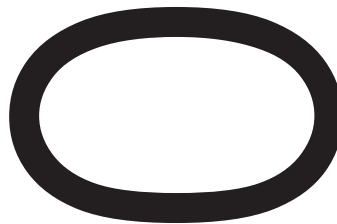
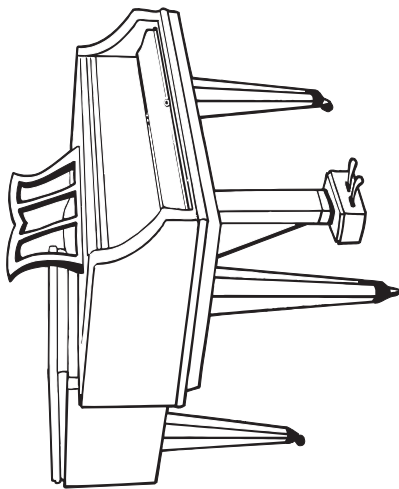
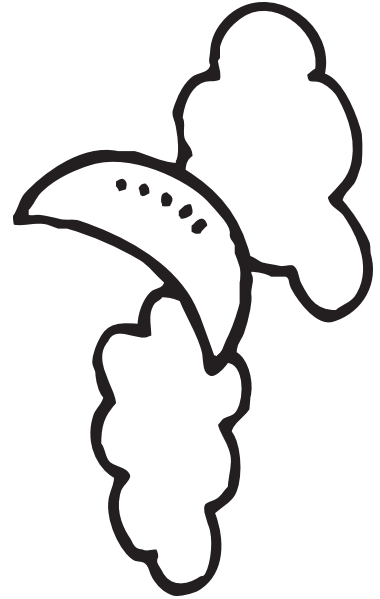
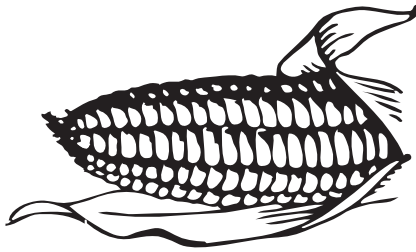
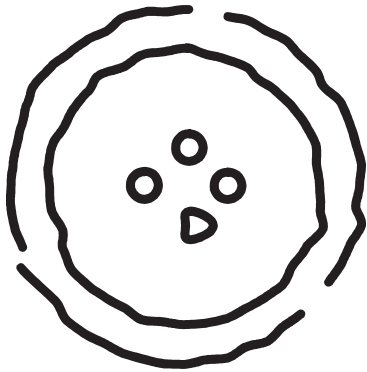

button, corn, moon, piano, zero, volcano



Phonics

Letter-Sound Correspondence Cards – Final

P.LSC-F.8

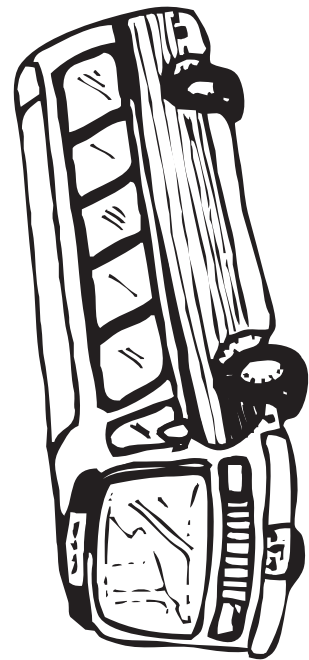
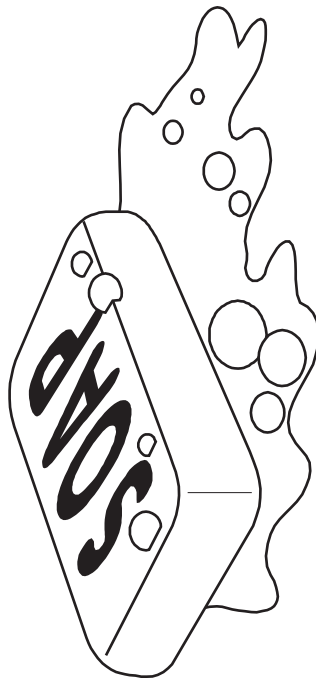
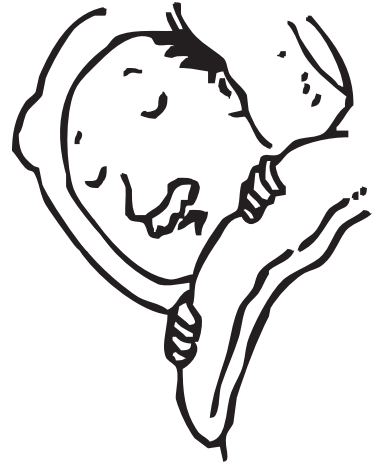
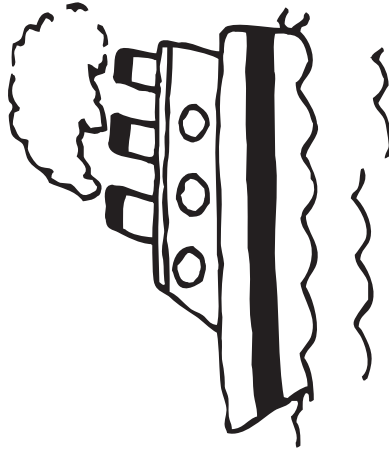

potato, ship, sleep, stop, soap, bus



P.LSC-F.9

Letter-Sound Correspondence Cards – Final

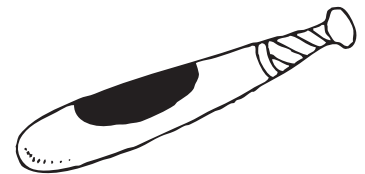
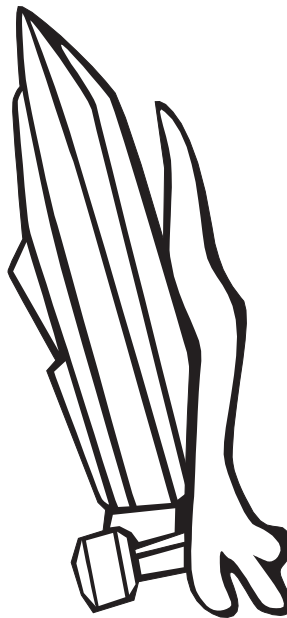

gas, kiss, octopus, carrot, boat, bat



Phonics

Letter-Sound Correspondence Cards – Final

P.LSC-F.10

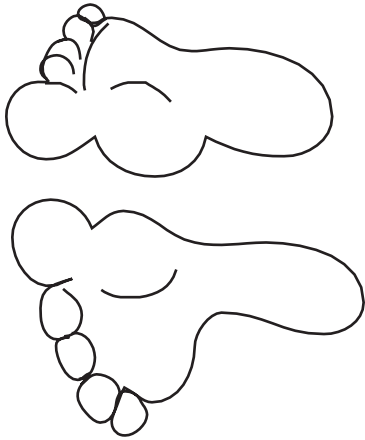

5

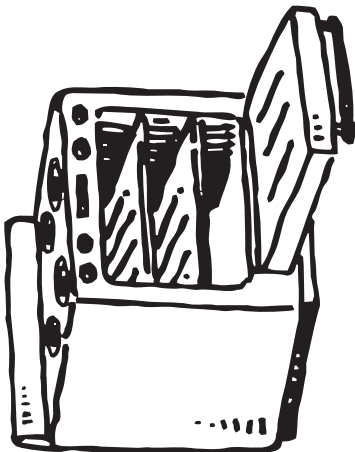

feet, five, sleeve, stove, cave, ox



P.LSC-F.1.1

Letter-Sound Correspondence Cards – Final

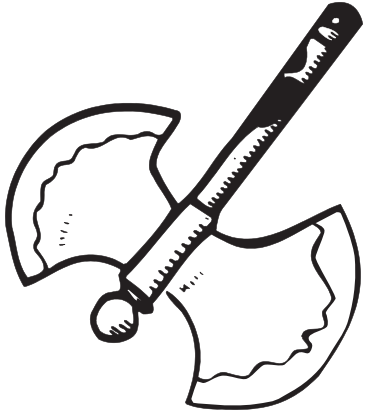

6

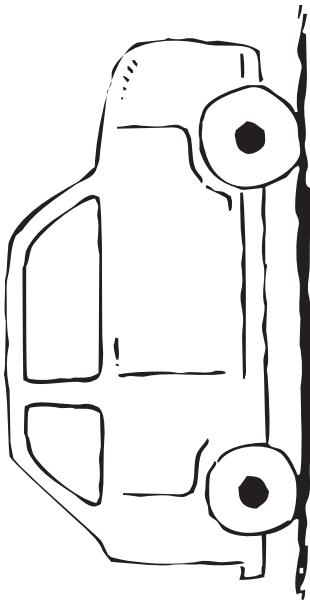
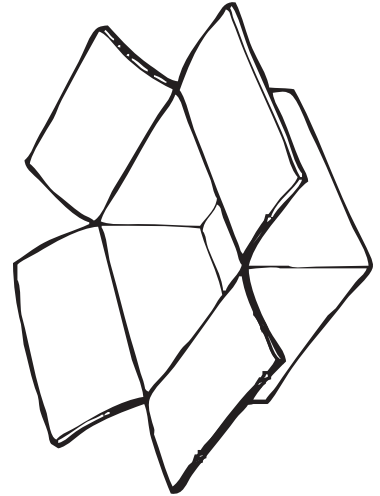

ax, six, box, car, star, jar



Phonics

Letter-Sound Correspondence Cards – Final

P.LSC-F.12

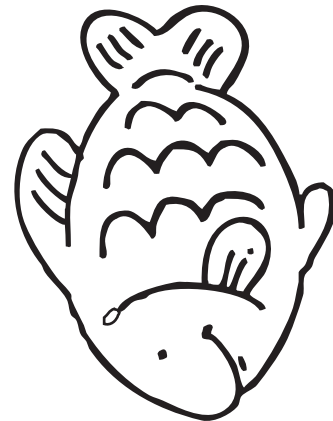
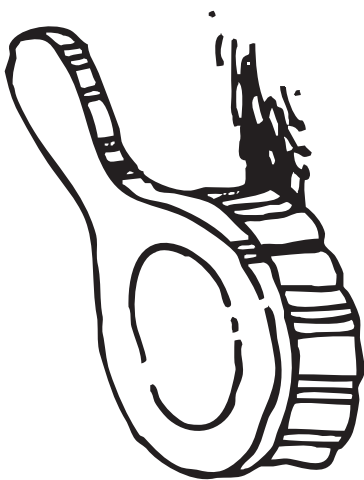
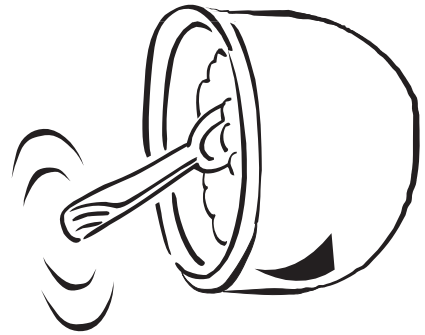
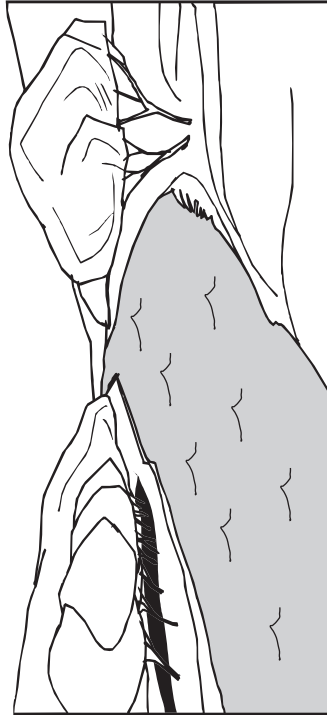

shower, river, stir, brush, dish, fish



P.LSC-F.13

Letter-Sound Correspondence Cards – Final

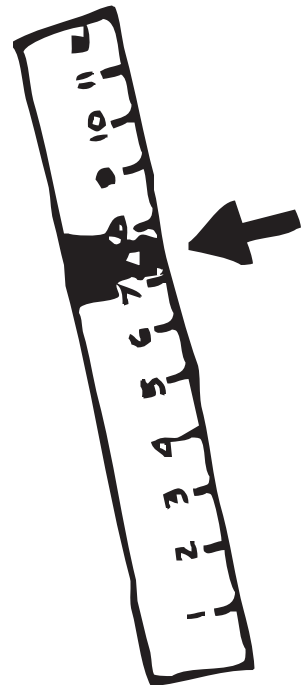
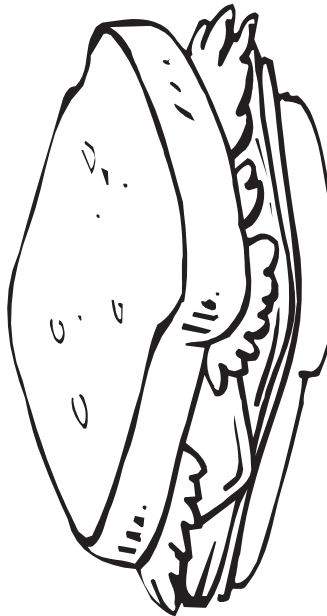
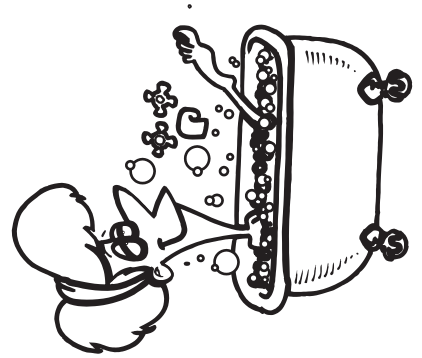

trash, tooth, bath, watch, sandwich, inch



Phonics

Letter-Sound Correspondence Cards – Final

P.LSC-F.14

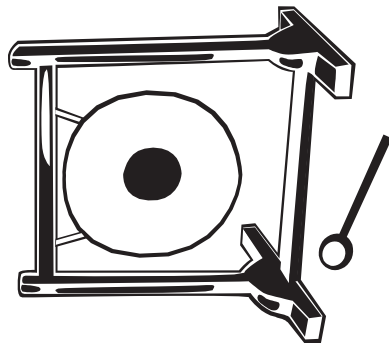
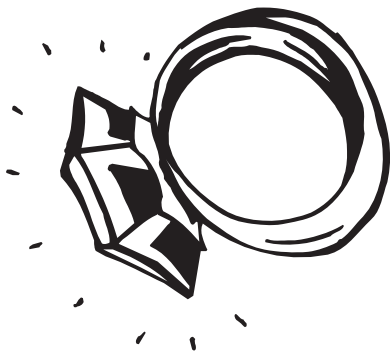
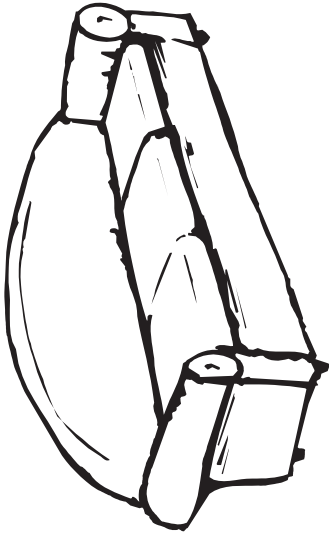

couch, king, swing, ring, gong, cow



P.LSC-F.15

Letter-Sound Correspondence Cards – Final

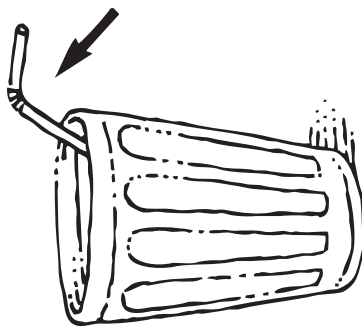
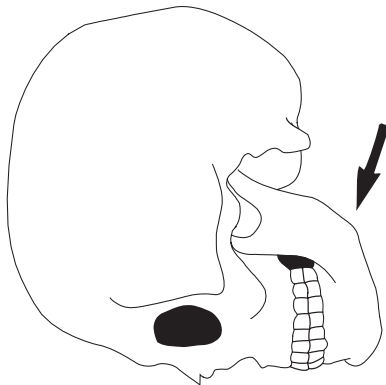
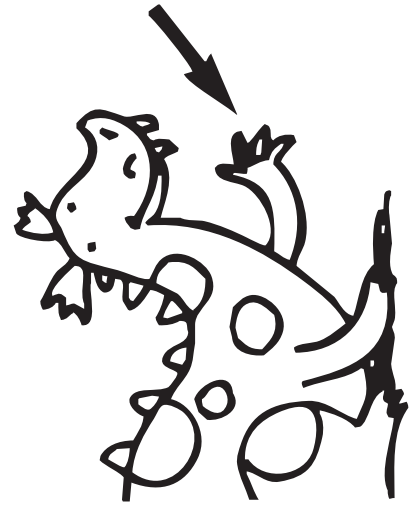
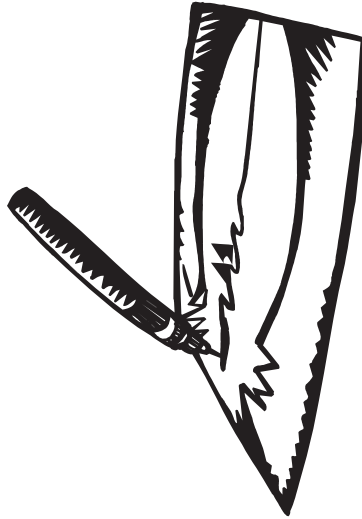

plow, draw, claw, jaw, straw, paw



Phonics

Letter-Sound Correspondence Cards – Final

P.LSC-F.16

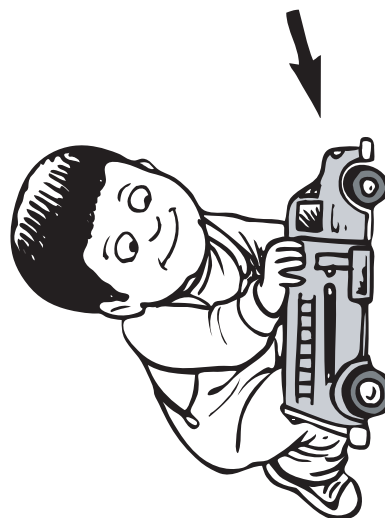
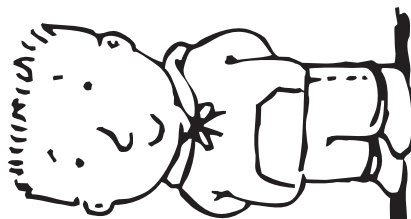
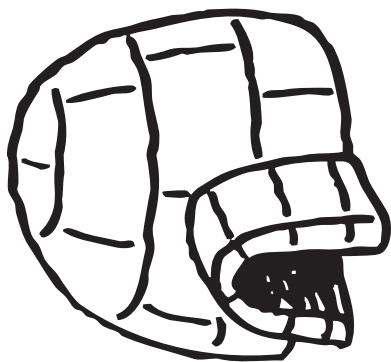
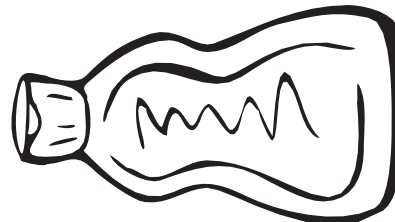
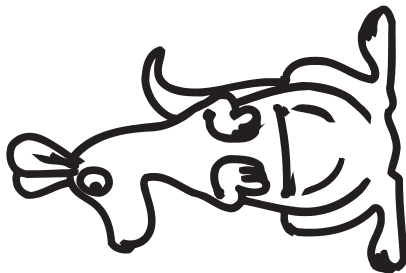

zoo, kangaroo, shampoo, igloo, boy, toy

